



# ULTIMHEAT

---

## HEAT & CONTROLS



(ATEX, IECEx, CCCEx)

# EXPLOSION PROOF THERMOSTATS & CONNECTION BOXES

- Thermostats without Explosion proof certification:
- Thermostats incorporated inside various boxes, housing & cabinets:
- Heat tracing connection boxes and accessories for non explosive areas

See catalogues No. 1

See catalogue No. 2 & 3

See catalogue No. 12

Contact us





















## Summary

Section 1	Summary.	Page Cat4-4-1-1~6	1-6
Section 2	 Historical and Technical introduction.	Page Cat4-4-2-1~6	1-6
Section 3	Alphabetical product list, and numerical reference list.	Page Cat4-4-3-1~4	1-4

### Fixed temperature limiters for incorporation, **wires or cables** electrical connection

Page Cat4-4-4-1~14

1-14





















Section 4	<b>Technical introduction on Thermostats for potentially explosive environments</b>			3-4	
		UZ	 II 2G Ex mb IIC T4 Gb   II 2D Ex mb IIIC T125°C Db	TYPE UZ. Miniature surface mounting disc limiter, cable output, rating 6A 240VAC max, calibration temperature from <b>50 °C to 100°C</b> (Current sensitive)	5-6
		UX	 II 2G Ex mb IIC T3 Gb   II 2D Ex mb IIIC T150°C Db	TYPE UX. Miniature surface mounting disc limiter, cable output, rating 6A 240VAC max, calibration temperature from <b>50 °C to 130°C</b> (Current sensitive)	7-8
		4YC	Ex « n » (partial)	TYPE 4YC. IEC 60079-0: 2017 (Explosive atmospheres, general requirements), § 26.5.1.2 and IEC 60079-15: 2017 (Explosive atmospheres, Equipment protection by type of protection “n”) § 9; 11.2.1; 11.2.2; and 11.2.3.1, when R290 highly flammable refrigerant classed A3 upon ISO 817, as found in air conditioning and heat pumps, may be present (See IEC/EN60335-2-40). Maximum rating 9A 240VAC. Waterproof. (TÜV certificate GC/70269203) Calibration temperature <b>5 to 85°C</b>	9
		4VA	 II 2G Ex mb IIC T4 Gb   II 2D Ex mb IIIC T125°C Db	TYPE 4VA. Disc limiters, <b>red</b> output. Rating 10A 240VAV. Temperature calibration from <b>5 to 100°C</b> . Various body design available (A, B, C, D, E, F), for ambient control, surface control or liquids control. It is possible to design new bodies without request to apply for new approvals	10-11
		4VB	 II 2G Ex mb IIC T4 Gb   II 2D Ex mb IIIC T125°C Db	TYPE 4VB, Disc limiters <b>wires</b> output. Rating 10A 240VAC. Temperature calibration from <b>5 to 100°C</b> . Various body design available (A, B, C, D, E, F), for ambient control, surface control or liquids control. It is possible to design new bodies without request to apply for new approvals	
		4XA	 II 2G Ex mb IIC T3 Gb   II 2D Ex mb IIIC T150°C Db	TYPE 4XA. Disc limiters <b>red</b> output. Rating 10A 240VAC. Temperature calibration from <b>5 to 130°C</b> . Various body design available (A, B, C, D, E, F), for ambient control, surface control or liquids control. It is possible to design new bodies without request to apply for new approvals	12-13
		4XB	 II 2G Ex mb IIC T3 Gb   II 2D Ex mb IIIC T150°C Db	TYPE 4XB, Disc limiters <b>wires</b> output. Rating 10A 240VAC. Temperature calibration from <b>5 to 130°C</b> . Various body design available (A, B, C, D, E, F), for ambient control, surface control or liquids control. It is possible to design new bodies without request to apply for new approvals	12-13

Because of permanent improvement of our products, drawings, descriptions, features used on these data sheets are for guidance only and can be modified without prior advice







Section 5		KAB-K	II 2G Ex db IIC T5/T6 Gb  II 2D Ex tb IIIC T95°C/ T80°C Db	Temperature control, front or rear mounting, wires connection. Multiples temperature ranges from <b>-50°C to +500°C</b> . NC: 16(4)A NO:10(2)A, 125/250/400 VAC; 50/60 Hz; -60°C to +50°C (T6/T80°C) NC: 16(4)A NO:10(2)A, 125/250/400 VAC; 50/60 Hz; -60°C to +80°C (T5/T95°C) NC: 25(4)A NO:15(2)A, 125/250 VAC; 50/60 Hz; -60°C to +50°C (T5/T95°C)	3-6
		KAB-L	II 2G Ex db IIC T5/T6 Gb  II 2D Ex tb IIIC T95°C/ T80°C Db	Temperature control, Din Rail mounting, wires connection. Multiples temperature ranges from <b>-50°C to +500°C</b> . NC: 16(4)A NO:10(2)A, 125/250/400 VAC; 50/60 Hz; -60°C to +50°C (T6/T80°C) NC: 16(4)A NO:10(2)A, 125/250/400 VAC; 50/60 Hz; -60°C to +80°C (T5/T95°C) NC: 25(4)A NO:15(2)A, 125/250 VAC; 50/60 Hz; -60°C to +50°C (T5/T95°C)	7-10
		KAB-3	II 2G Ex db IIC T5/T6 Gb  II 2D Ex tb IIIC T95°C/ T80°C Db	Temperature control, front or rear mounting, cable connection. Multiples temperature ranges from <b>-50°C to +500°C</b> . NC: 16(4)A NO:10(2)A, 125/250/400 VAC; 50/60 Hz; -60°C to +50°C (T6/T80°C) NC: 16(4)A NO:10(2)A, 125/250/400 VAC; 50/60 Hz; -60°C to +80°C (T5/T95°C) NC: 25(4)A NO:15(2)A, 125/250 VAC; 50/60 Hz; -60°C to +50°C (T5/T95°C)	11-14
		KAB-4	II 2G Ex db IIC T5/T6 Gb  II 2D Ex tb IIIC T95°C/ T80°C Db	Temperature control, Din Rail mounting, cable connection. Multiples temperature ranges from <b>-50°C to +500°C</b> . NC: 16(4)A NO:10(2)A, 125/250/400 VAC; 50/60 Hz; -60°C to +50°C (T6/T80°C) NC: 16(4)A NO:10(2)A, 125/250/400 VAC; 50/60 Hz; -60°C to +80°C (T5/T95°C) NC: 25(4)A NO:15(2)A, 125/250 VAC; 50/60 Hz; -60°C to +50°C (T5/T95°C)	15-18
		8Z	Ex « n » (partial)	TYPE 8Z. 1, 2, 3-pole manual reset limiter. Fixed setting. Comply with IEC 60079-0, IEC 60079-15. <b>To use when R290 highly flammable refrigerant classed A3 upon ISO 817 may be present. This is not a Ex certified product.</b> Maximum rating 20 (3.3)A 250V, 16(2.6)A 400V Waterproof. Calibration from <b>70°C to 130°C</b>	19-21
		81	Ex « n » (partial)	<b>81:</b> 3 poles manual reset fail safe temperature limiters, double break contacts, calibration up to 130°C(266°F), 6.35 tabs, rating 25 A (3,3 A) à 250 V, 20 A (2,6 A) 400 V, rear mounting, <b>to use when R290 highly flammable refrigerant classed A3 upon ISO 817 may be present. This is not Ex certified product but made specially for heat pumps applications</b>	22-23

Because of permanent improvement of our products, drawings, descriptions, features used on these data sheets are for guidance only and can be modified without prior advice

Because of permanent improvement of our products, drawings, descriptions, features used on these data sheets are for guidance only and can be modified without prior advice







Connection boxes and enclosures with or without connection blocks, intended to receive KA, KY, or KZ thermostats, specially designed for heat tracing <b>and pipe mounting</b>					Page Cat4-4-6-1~20	1-20
<b>Technical introduction to connection boxes</b>						3-6
Section 6		Y92 Y93	 II 2G Ex eb IIC T6/T5/T4 Gb   II 2D Ex tb IIIC T80°C/T95°C/T125°C Db	Electrical heat tracing connection boxes, for mounting on pipes (Y92), poles or vertical walls (Y93), intended for the incorporation of connection blocks, mechanical or electronic thermostats.		7-13
		Y92***KA***** Y93***KA*****	 II 2G Ex eb IIC T6/T5 Gb   II 2D Ex tb IIIC T80°C/T95°C Db	Some examples of bulb and capillary thermostats, with set point adjustment, with pipe mounting leg (Y92***KA) or pole/wall mounting bracket (Y93***KA), rating up to 25A		14-21
Connection boxes and enclosures with or without connection blocks, intended to receive KA, KY, or KZ thermostats, specially designed for <b>wall mounting</b>					Page Cat4-4-7-1~18	1-16
Section 7		Y9A0	 II 2G Ex eb IIC T6/T5/T4 Gb   II 2D Ex tb IIIC T80°C/T95°C/ T125°C Db	Connection boxes with M20 and M25 cable glands and 35mm DIN Rail		3-4
		Y9B1 Y9D1	 II 2G Ex eb IIC T6/T5 Gb   II 2D Ex tb IIIC T80°C/T95°C Db	Connection boxes with one M20 and one M25 cable glands and one bulb and capillary thermostat with internal or external adjustment, capillary output on bottom side		5-6
		Y9C1 Y9E1	 II 2G Ex eb IIC T6/T5 Gb   II 2D Ex tb IIIC T80°C/T95°C Db	Connection boxes with two M20 and one M25 cable glands and one bulb and capillary thermostat with internal or external adjustment, capillary output on lateral side		7-8
		Y9C3 Y9E3	 II 2G Ex eb db IIC T6/T5 Gb   II 2D Ex tb IIIC T80°C/T95°C Db	Connection boxes with two M20 and one M25 cable glands and one bulb and capillary thermostat with internal or external adjustment, capillary output on lateral side, ambient temperature bulb		9-10
		Y9B5 Y9E5	 II 2G Ex eb IIC T6/T5 Gb   II 2D Ex tb IIIC T80°C/T95°C Db	<b>Y9B5: flat cover for inside adjustment, 140 × 110 × 90mm for one KA</b> <b>Y9E5: cover with knob outside adjustment, 140 × 110 × 100mm for one KA</b>  Rectangular PPS enclosure, wall mounting, only one M25 and one M20 cable gland on 90 × 110mm side, one set of 6 ways 4mm <sup>2</sup> connection blocks, including one ground connection block. <u>Bulb and capillary output is made inside pocket located on backside.</u> Low temperature maximum set point (≤300°C). Pocket with 1/2" thread (other sizes in option) Pocket length to be specified. Rating up to 25A		11-12



Section 7		<p>Y9B6 Y9E6</p>	<p> II 2G Ex eb IIC T6/T5 Gb</p> <p> II 2D Ex tb IIIC T80°C/T95°C Db</p>	<p><b>Y9B6: flat cover for inside adjustment, 140 × 110 × 90mm for one KA</b> <b>Y9E6: cover with knob outside adjustment, 140 × 110 × 100mm for one KA</b></p> <p>Rectangular PPS enclosure, wall mounting, only one M25 and one M20 cable gland on 90 × 110mm side, one set of 6 ways 4mm<sup>2</sup> connection blocks, including one ground connection block. <u>Bulb and capillary output is made inside pocket located on backside.</u> High temperature maximum set point (&gt;300 ≤500°C). Pocket with heat exchanger and ½" thread (other sizes in option) Pocket length to be specified. Rating up to 25A</p>	13-14
		<p>Y9TV</p>	<p> II 2G Ex eb IIC T6 Gb</p> <p> II 2D Ex tb IIIC T80°C Db</p>	<p>TYPE Y9TV. Disc limiter <b>inside enclosure with screw terminals connection box.</b> Electrical rating 10A 240VAC. Calibration from <b>5 to 80°C.</b> Connection block for 0.5 to 4mm<sup>2</sup> wires, 3 to 9 terminals. 1 or 2 M20 cable glands.</p>	15-16

**Connection boxes and enclosures with built-in connection blocks, intended to be used with round standard wires or self-regulated flat heating wires. Not available with thermostats. Wall or pipe mounting.** Page Cat4-4-8-1~18

1-18

Section 8		<p>6YTEW</p>	<p> II 2G Ex eb IIC T5 Gb</p> <p> II 2D Ex tb IIIC T95°C Db</p>	<p>TYPE 6YTEW. Heating cable termination. Can be used on standard heating cable or explosion proof heating cable. Maximum temperature <b>95°C.</b> Seals are selected in factory based on dimensions of heating cable sample received.</p>	3-5
		<p>Y40</p>	<p> II 2G Ex eb IIC T5 Gb</p> <p> II 2D Ex tb IIIC T95°C Db</p>	<p>TYPE Y40. Self-stripping junction box in PPS, with <b>2 M25 cable glands.</b> Can be used on standard heating cable or explosion proof heating cable. Maximum temperature <b>95°C.</b> Rating <b>32A, 6mm<sup>2</sup></b> Seals are selected in factory based on dimensions of heating cable sample received. Available with flat wall mounting bracket or with plastic or stainless-steel brackets for pipe mounting</p>	6-13
		<p>Y41</p>	<p> II 2G Ex eb IIC T5 Gb</p> <p> II 2D Ex tb IIIC T95°C Db</p>	<p>TYPE Y41. Self-stripping junction box in PPS, with <b>four M25 cable glands.</b> Can be used on standard heating cable or explosion proof heating cable. Maximum temperature <b>95°C.</b> Rating <b>32A, 6mm<sup>2</sup></b> Seals are selected in factory based on dimensions of heating cable sample received. Available with flat wall mounting bracket or with plastic or stainless-steel brackets for pipe mounting</p>	14-18

Because of permanent improvement of our products, drawings, descriptions, features used on these data sheets are for guidance only and can be modified without prior advice

Because of permanent improvement of our products, drawings, descriptions, features used on these data sheets are for guidance only and can be modified without prior advice

Standard accessories for enclosures and thermostats			Page Cat4-4-9-1~16	1-16
Section 9		66MQ, 66MG 66MZ, 66ME 66CP, 66EN	Knobs and dials for explosion proof thermostats	3-5
		6YTQW46, 6YTQV47, 6YTQP46	Pipe mounting legs for explosionproof enclosures	6-9
		BW  II 2 G D Ex eb IIC Gb	ATEX connection blocks, 4mm <sup>2</sup> and 6mm <sup>2</sup> for <b>line and neutral</b> , for EX "e" enclosures	10-13
		BX  II 2 G D Ex eb IIC Gb	ATEX connection blocks, 4mm <sup>2</sup> and 6mm <sup>2</sup> for <b>ground</b> , for EX "e" enclosures	14-16
Special tools			Page Cat4-4-10-1~8	1-8
Section 10		6YTTL03	<b>Exclusive</b> hexagonal crimping plier ( <b>exclusive model</b> ).	3
		6YTTL04	<b>Exclusive</b> stripping pliers for heat tracing cables with <b>dedicated</b> cutting blades according to all cable dimensions.	4-6
		6YTTL05	<b>Exclusive</b> tool for cutting the heating zone between the conductors (for flat self-regulating cables). Also allows to cut one of the two conductors and its insulation over 5mm in order to maintain safety isolation distances at the end of self-regulating heating cables ( <b>exclusive model</b> ).	7-8



Because of permanent improvement of our products, drawings, descriptions, features used on these data sheets are for guidance only and can be modified without prior advice



# **Section 2**

## **Historical and Technical introduction to explosion proof thermostats**



Because of permanent improvement of our products, drawings, descriptions, features used on these data sheets are for guidance only and can be modified without prior advice

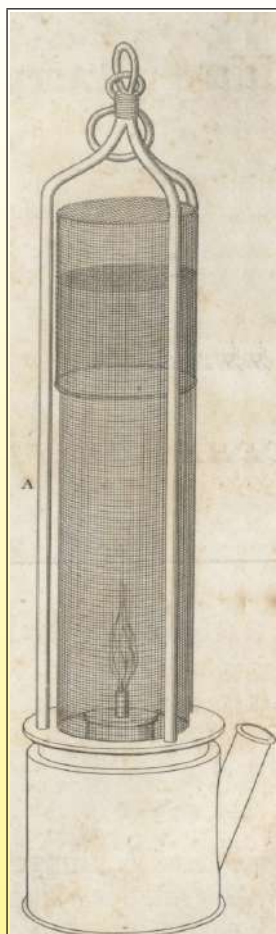

1815 the miner safety lamp, invented by Humphry Davy

The explosion of firedamp in mines caused by the flames of oil lamps, was the cause of many accidents and caused hundreds of deaths. This explosion had a double danger: Methane gas and coal dust. When the methane exploded, the explosion was generally followed by a much more violent explosion of dust (the dust explosion) produced by inflammation of the cloud of coal dust produced by the initial explosion.

The oldest listed, but certainly not the first tragedy, was the one of the pit of the Barbeau de Wez, near Liège in Belgium, which caused 94 victims in 1514.

The first solution was to hire minors, volunteers and paid more to ignite the gas every day.

Firedamp was "lit" before the miners arrival. For this purpose, a worker called penitent (because of the suit which he was clothed) or gunner, covered with wet leather or fabric clothes, face protected by a mask equipped with glass windows and carrying a lighted candle, was responsible for igniting the gassy pockets, mostly located in the upper parts of galleries.

Alphonse Meugy describes how to operate in his book, "History of the Mines in Rive-de-Gier" (1848):

*"Two workers called gunners used to go down to the mine a few hours before their peers, with strong canvas clothes, and covered with a kind of head cap. They were moving at a certain distance of the working faces and while one of them was hiding in a nearby gallery, the other one, armed with a pole bearing a burning wick at its end, was approaching by crawling until the flame of the wick was beginning to grow. He then was laying, face to the ground with his clothes soaked and was lifting the pole to the top of the excavation. This was producing a detonation which often had the effect of seriously injuring the gunner. He was rescued by his colleague."*

Ponies carrying a lit candle were also used. They were watered then sent to the galleries in the hope of creating tiny explosions.

After many accidents, the English Humphry Davy discovered in 1815 that a flame enclosed in a very fine mesh does not ignite firedamp. Miners lighting became safer.

The practice of the "penitent" or "gunner" was gradually outlawed in the mines around 1835, after the Davy lamp being almost universally used in France since 1823.

This lamp, which was called "the Davyne" in France, seemed likely to provide all the necessary safety guarantees against ignition of firedamp but after many explosions occurred in coal mines where this lamp was used, it was soon demonstrated it was not flawless, and that it could only reduce the chances of explosions, without preventing them in all cases. In particular, it had the following defects:

- *The inflammation of a mixture of air and carbon hydrogen can occur through the metallic canvas, in galleries where there is a quick airflow, because then, the lamp flame blushes the mesh or passes through.*
- *The slightest shock can deform or even tear open the mesh, and thus render the lamp ineffective.*
- *The metal-mesh in contact with the oil reservoir, is soon greased and traps fuel dust, thus forming a paste which can be ignited, both inside and outside.*

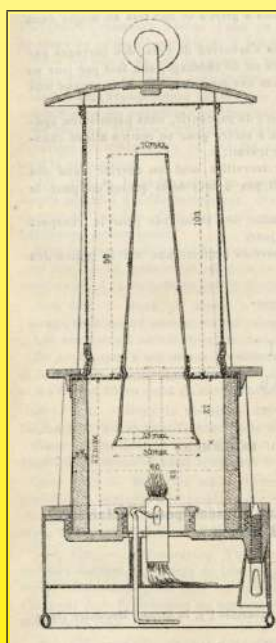

1842 The Mueseler miner lamp

In 1842 the Liège Mathieu-Louis Mueseler invented a lamp that had the following advantages:

- *It is quickly extinguished when there is plenty of explosive gases, even in a mixture with pure hydrogen.*
- *It shines best and can be placed away from the worker and free tools, and best suited in galleries having strong air streams.*
- *The wire mesh, being remote from the tank, do not permeate to oil. Only a dry dust can stick but it is easily removable.*
- *It is provided with two wire meshes, one horizontal and the other vertical, so that one remains intact when the second is to be torn.*
- *Finally, the air flow to activate the combustion is from top to bottom instead of being laterally, provision that gives the inestimable advantage over all other safety lamps, of turning off suddenly when the air is charged with sufficient carbon hydrogen to provide an explosive mixture.*

*This lamp spread in the basin of Seraing and other coal centers in Belgium and, in 1864, its use was prescribed by the Belgian Government. It was then adopted in a number of mines in France and England.*

Lighting miners became safer. The use of these lamps, however remained linked to the respect of safety, and there were many accidents resulting from human carelessness. Here is an example, one of my ancestors, Auguste-Joseph Jumeau, was one of the victims:

On Saturday, March 6, 1852, at the pit "Ferrand" at Elouges in The Borinage (Belgium), the morning shift just came down in the galleries, it was the last day of work in this mine, as it should be closed to allow upgrades and safety works. The pit had a small diameter and allowed a two buckets traffic only (large casks used to bring the coal up to the surface and the movements of people) attached to hemp ropes.

At 20 meters of the hanging point, at the entrance of a gallery, was a tank containing water for the mine horses. Around 10 AM, the worker in charge of treating horses went there to draw water. As the lamp did not light enough (probably a Davy lamp type), he imprudently opened it. As soon as the flame in contact with the atmosphere, an explosion rocked the mine. The horse trainer was thrown against a wall and was horribly burned. He survived nevertheless. His many companions were less fortunate: 63 miners, men, women and children were killed.



1862 Dumas et Benoît's  
Electrical miner lamp

A risk still remained to be solved: The ignition of the lamp, which forced to back it out of the well if accidentally extinguished. In the 1890's, when kerosene replaced oil in lamps, electric ignition systems for miner lamps were tested, having enclosures that did not let the flame out (Patent by William Ackroyd, Morley, England).

The first electric portable lamps with batteries offered at the Academy of Sciences of Paris in 1862 by MM. Dumas and Benoit, did not definitely meet safety requirements, unlike earlier expectations that set forth their lighting tube enclosed in a sealed tube as not fearing the ignition of firedamp (featured in the Journal of Industrial Engineering, July 1863).

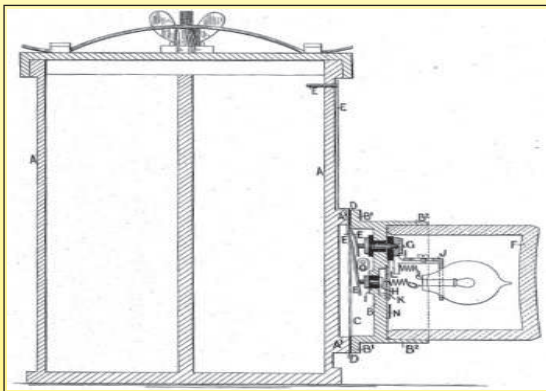

1884 Cad electrical lamp

In 1884, English Theophilus Cad, from Forest Gate, England, invented an electric lamp whose switch was enclosed in what can be considered the first electrical flameproof enclosure (British Patent No. 806 of 5 January 1884).

Timidly used from 1890, electric lamps grew very slowly between 1920 and 1930.

But shortly after the introduction of electricity in coal mines, it was also discovered that lethal explosions could be initiated by fixed electrical equipment such as lighting, signals or motors.

Around 1910, 12 volts DC signaling systems considered safe appeared.

However, in October 1913, took place the largest explosion of British mines, that of Senghenydd Colliery, where 439 miners perished. It was suspected an alarm system, consisting of two parallel bare wires running along the galleries, which allowed any miner wishing to report a problem to the surface to make it by contacting momentarily the two wires with a metal tool. But the bell inductance coils caused a spark, which was probably the cause of the explosion. It was then determined that these products might be secured by a careful design, the forerunner of the "intrinsic safety". Following this disaster, the miners demanded the withdrawal of the electrical equipment of pits. Then began the development of electric devices called "explosion proof", which inevitable sparks could only occur in a protective envelope preventing from igniting the surrounding gas.

Historically, the topic of Hazardous (Classified) Locations first appeared in the National Electrical Code (NEC) in 1923, when a new article entitled "Extra-Hazardous Locations" was accepted. This article addressed rooms or compartments in which highly flammable gases, liquids, mixtures or other substances were manufactured, used, or stored.

In the investigations leading to approval of loading and conveying machines the bureau is guided by the provisions of Schedule 2C. issued on February 3, 1930. This schedule classified the various electrical parts according to their liability to sparking and specified the type of enclosure to be used for each class. As required by the schedule, a part that may produce sparks during normal operation must be enclosed in an explosion-proof casing; that is, an explosion of gas in such a casing must not ignite the gas surrounding the casing or discharge flames from any joints, bearings, or lead entrances. The object of the bureau's investigations is therefore to determine by test and inspection whether or not the enclosures are suitable to the purpose for which designed. The explosion-proof qualities are demonstrated by tests in which gas is exploded within the casings. Other tests are made to check the adequacy of electrical clearances and insulation. In addition to the tests, a detailed inspection of parts, including a careful check against drawings and specification is made. These drawings constitute the chief record of the equipment investigated

and therefore must be complete in detail to cover adequately the construction to be approved. A description of test equipment and methods followed in conducting these investigations is given in Bureau of Mines Bulletin 305, Inspection and Testing of Mine-Type Electrical Equipment for Permissibility, published in 1929.

In Europe, the first German standards on “ The protection of electrical installations in hazardous areas ” were published in 1935, and gave guidelines for the installation of electrical equipment in hazardous areas. In 1938 appeared a fundamental change dividing the installation requirements (VDE 0165) and the design requirements of products (VDE 0170 / 0171 ).

Standards of product design included the types of basic protection against explosions such as flameproof enclosures, immersion in oil and increased safety. Components were designed to be protected against explosions and housed in industrial type housings that were resistant to weathering. This led to the development of flameproof components mounted inside increased safety housings. Devices designed to this standard were marked with the symbol (Ex). During the 1960's, the European Community was founded to establish a free trade area in Europe. **To reach this goal, technical standards needed to be harmonized.** Consequently, the European Organisation for Electrotechnical standardization (CENELEC) was created. A new set of European standards describing devices for explosive environments (EN 50014 - EN 50020) was published in 1972. In 1975, the first EU directive for devices used in hazardous areas, known as “ Directive on the protection against explosions ”, was published. In 1978, the first edition of European standards was published by CENELEC which covered installation techniques.

It must be noted that the standards were taking in account the original comments of Davy on the gas inflammation in contact with the overheated protection grid of miners lamps by issuing rules about the surface temperature of enclosures (T), and also the minimum interstice to avoid the flame passage “ e ”.

IEC standards currently in force in 2014 for equipment for explosive atmospheres are:

- IEC 60079-1: Flameproof enclosures “ d ”,
- IEC 60079-2: Envelopes internal pressure “ p ”,
- IEC 60079-5: Powder filling “ q ”,
- IEC 60079-6: Oil immersion “ o ”,
- IEC 60079-7: Increased safety “ e ”,
- IEC 60079-11: Intrinsic Safety “ i ”,
- IEC 60079-15: Type of protection “ n ”,
- IEC 60079-18. Encapsulation “ m ”.

They are supplemented by the following equipment standards:

- IEC 60079-25,
- IEC 60079-26,
- IEC 62013-1,
- IEC 62086-1.

At their transcription into European standards, the IEC prefix is replaced by EN.



## Protections systems against explosions used in products described in this catalogue

**Electromechanical thermostats** have an important characteristic that makes critical their use in potentially explosive atmospheres: The opening and closing of their electrical contact, which occurs regularly during their normal operation, produces a spark between the contacts. If they are not intended and designed specifically for being used in hazardous areas, their use becomes particularly dangerous because this spark is sufficient to ignite the surrounding atmosphere.

Historically, the solution was to use standard thermostats, and enclose them in a cast iron enclosure, with large sealing surfaces and a minimum gap between cover and frame, (described as “ d ” style enclosures in EN 60079-1, formerly EN50018), so that if an explosion occurred around the electrical contact, it could not extend outside the enclosure. This resulted in heavy, massive and bulky devices because this enclosure had itself to withstand the explosive ignition of the gas mixture which filled it.

Although this solution is still used by some manufacturers, we have developed over the past 10 years a concept for light and compact products, limiting the flameproof area to the immediate environment of the switch.

This solution allows for devices with a direct output cable (or wires), avoiding the electrical connection inside the enclosure. Thermostats, whose sizes are similar to conventional thermostats can be incorporated, according to the customer’s choice, in their own mechanical protection enclosure and electrical connection is carried away in a junction box that meets the applicable requirements of environment and hazardous areas standards. This is the reason why you will find different types of thermostats for explosive atmospheres in this catalog:

- **Thermostats with wires electrical connection:** (They are those having the smallest footprint) to allow installation and connection in a increased safety (Ex ‘e’ ) enclosure, but because of their components approval, it is required to apply for an additional approval of the customer enclosure with all its equipment. This solution, although these models of thermostats are the most economical, is therefore valid for large quantities applications only.

- **Thermostats with cable electrical connection:** In these devices, the thermostat and cable are considered as a product, and meet the hazardous area requirements if their installation instructions are fulfilled. In particular, they can be used without additional protective enclosure, by, for example, mounting them directly on a panel. It is not necessary to request an additional certificate. This solution also allows mounting the thermostat in a mechanical and ingress protection enclosure, which is not certified as equipment for explosive atmospheres. However, the cable must be mechanically protected, and the connection at its end must be made in a increased safety (Ex ‘e’) approved junction box or outside the hazardous area.

- **Thermostats incorporated inside increased safety metal enclosures, (Ex approval “ d ” + “ e ” ).**

The explosion-proof thermostat is installed and connected in an increased safety enclosure, specially designed for thermostat. This solution allows electrical connection inside the housing, but does not allow thermostat set point adjustment by opening the enclosure when energized. The cable exits and the capillary cable gland must be Ex-“ e ” certified cable glands, and the terminals are also Ex-“ e ” certified, and cannot be modified or replaced by other models without cancelling the approval.



---

# **Section 3**

## **Alphabetical product list, and numerical reference list**



Because of permanent improvement of our products, drawings, descriptions, features used on these data sheets are for guidance only and can be modified without prior advice



## References list

Because of permanent improvement of our products, drawings, descriptions, features used on these data sheets are for guidance only and can be modified without prior advice

Reference	Reference	Reference	Reference
0000603AW	4VB1A00*007060D0	66CP02*****	81E110140AD65001
0000603AX	4VB1A00*008070D0	66EN1	81E120150AH65001
000060CAW	4VB1A00*00A090D0	66EN2	81E120150AD65001
000060CAX	4XA1A00*00A595D0	66KA1560	81E130160AH65001
0040403AW	4XA1A00*00B0A0D0	66KA3560	81E130160AD65001
0040403AX	4XA1A00*00D0C0D0	66KAMB35356	
004040CAW	4XA1A00*00E0D0D0	66KARE570	
004040CAX	4XA1A00*00G0F0D0	66ME006*****	8Z36070100N096N0
0300903AW	4XA1A30*00A595D0	66MG006*****	8Z36070100N056N0
0300903AX	4XA1A30*00B0A0D0	66MQ	8Z36080110N096N0
030090CAW	4XA1A30*00D0C0D0	66MQ006	8Z36080110N056N0
030090CAX	4XA1A30*00E0D0D0	66MZ	8Z36090120N096N0
0301103AW	4XA1A30*00G0F0D0	66MZ006*****	8Z36090120N056N0
0301103AX	4XA1A60*00A595D0	6YTEW16S0F50100	8Z36110140N096N0
030110CAW	4XA1A60*00B0A0D0	6YTEW26S0F50110	8Z36110140N056N0
030110CAX	4XA1A60*00D0C0D0	6YTEW36S0F50120	8Z36120150N096N0
0502003AW	4XA1A60*00E0F0D0	6YTEW46S0F60130	8Z36120150N056N0
0502003AX	4XA1A60*00G0F0D0	6YTEW56S0R60000	8Z36130160N096N0
050200CAW	4XB1A00*00A595D0	6YTEW66S0R70000	8Z36130160N056N0
050200CAX	4XB1A00*00B0A0D0	6YTPF160032	8Z30070100N096N0
0503003AW	4XB1A00*00D0C0D0	6YTQPV46	8Z30070100N056N0
0503003AX	4XB1A00*00E0D0D0	6YTQTV46	8Z30080110N096N0
050300CAW	4XB1A00*00G0F0D0	6YTQTV47	8Z30080110N056N0
050300CAX	4XB1A30*00A595D0	6YTQTV67	8Z30090120N096N0
-100403AW	4XB1A30*00B0A0D0	6YTQTV67	8Z30090120N056N0
-100403AX	4XB1A30*00D0C0D0	6YTQTV46	8Z30110140N096N0
-10040CAW	4XB1A30*00E0D0D0	6YTQTV46	8Z30110140N056N0
-10040CAX	4XB1A30*00G0F0D0	6YTQTV47	8Z30120150N096N0
-350353AW	4XB1A60*00A595D0	6YTQTV67	8Z30120150N056N0
-350353AX	4XB1A60*00B0A0D0	6YTQTV46	8Z30130160N096N0
-35035CAW	4XB1A60*00D0C0D0	6YTQTV47	8Z30130160N056N0
-35035CAX	4XB1A60*00E0D0D0	6YTQTV67	
4VA1A30*005040D0	4XB1A60*00G0F0D0	6YTQTV46	BW040BSTL
4VA1A30*007060D0	4YC1A10*0F5040D0	6YTQTV47	BW040BSTN
4VA1A30*008070D0	4YC1A10*0F7060D0	6YTQTV67	BW040C00L
4VA1A30*00A090D0	4YC1A10*0F7565D0	6YTQTV46	BW040C00N
4VA1A60*005040D0	4YC1A10*0F8070D0	6YTQTV47	BW040FSTL
4VA1A60*007060D0	4YC1A10*0F8575D0	6YTQTV67	BW040FSTN
4VA1A60*008070D0	4YC1A30*0F5040D0	6YTQTV46	BX040C00Y
4VA1A60*00A090D0	4YC1A30*0F7060D0	6YTQTV47	BX040FSTG
4VA1A00*005040D0	4YC1A30*0F7565D0	6YTQTV67	BX040FSTM
4VA1A00*007060D0	4YC1A30*0F8070D0	6YTQTV46	BX060C00Y
4VA1A00*008070D0	4YC1A30*0F8575D0	6YTQTV47	BX060FSTG
4VA1A00*00A090D0	4YC1A60*0F5040D0	6YTQTV67	BX060FSTM
4VB1A30*0F5040D0	4YC1A60*0F7060D0	6YTQTV46	KABA000060L62K
4VB1A30*0F7060D0	4YC1A60*0F7565D0	6YTQTV47	KABA000060L62L
4VB1A30*0F8070D0	4YC1A60*0F8070D0	6YTQTV67	KABA000060L6A3
4VB1A30*0FA090D0	4YC1A60*0F8575D0	6YTQTV46	KABA000060L6A4
4VB1A60*0F5040D0	66BW040(A, B, C, D, E, F)	6YTQTV47	KABA000100L82K
4VB1A60*0F7060D0	66BW040AL53	6YTQTV67	KABA000100L82L
4VB1A60*0F8070D0	66BW040S13	6YTQTV46	KABA000100L8A3
4VB1A60*0FA090D0	66BWBR75	6YTQTV47	KABA000100L8A4
4VB1A00*0F5040D0	66CP01*****	6YTQTV67	KABA000200LA2K
		6YTQTV46	KABA000200LA2L
		6YTQTV47	
		6YTQTV67	
		81E070100AH65001	
		81E070100AD65001	
		81E080110AH65001	
		81E080110AD65001	
		81E090120AH65001	
		81E090120AD65001	
		81E110140AH65001	



# Alphabetical product list, and numerical reference list



Reference	Reference	Reference	Reference
KABA000200LAA3	KABA-20050L32K	KABC050200LBA3	UZV1005053810B1
KABA000200LAA4	KABA-20050L32L	KABC050200LBA4	UZV1007055010B1
KABA000300LC2K	KABA-20050L3A3	KABC050300LD2K	UZV1008055710B1
KABA000300LC2L	KABA-20050L3A4	KABC050300LD2L	UZV1010056710B1
KABA000300LCA3	KABA-35035L12K	KABC050300LDA3	UZV3005053810B1
KABA000300LCA4	KABA-35035L12L	KABC050300LDA4	UZV3007055010B1
KABA004040L42K	KABA-35035L1A3	KABC050400LE2K	UZV3008055710B1
KABA004040L42L	KABA-35035L1A4	KABC050400LE2L	UZV3010056710B1
KABA004040L4A3	KABC000060L62K	KABC050400LEA3	UZV6005053810B1
KABA004040L4A4	KABC000060L62L	KABC050400LEA4	UZV6007055010B1
KABA004040L52K	KABC000060L6A3	KABC060500LF2K	UZV6008055710B1
KABA004040L52L	KABC000060L6A4	KABC060500LF2L	UZV6010056710B1
KABA004040L5A3	KABC000100L82K	KABC060500LFA3	Y40-**-**_****
KABA004040L5A4	KABC000100L82L	KABC060500LFA4	Y41-**-**_****_*****_*****
KABA030090L72K	KABC000100L8A3	KABC-10040L22K	Y92-**-**_****_*****_*****
KABA030090L72L	KABC000100L8A4	KABC-10040L22L	Y92-**-**_****_*****_*****
KABA030090L7A3	KABC000200LA2K	KABC-10040L2A3	Y93-**-**_****_*****_*****
KABA030090L7A4	KABC000200LA2L	KABC-10040L2A4	Y93-**-**_****_*****_*****
KABA030110L92K	KABC000200LAA3	KABC-20050L32K	Y9A0**-**_****_*****_*****
KABA030110L92L	KABC000200LAA4	KABC-20050L32L	Y9B1602-**-**_***
KABA030110L9A3	KABC000300LC2K	KABC-20050L3A3	Y9B560-**-**_****_*****
KABA030110L9A4	KABC000300LC2L	KABC-20050L3A4	Y9B660-**-**_****_*****
KABA050200LB2K	KABC000300LCA3	KABC-35035L12K	Y9C1602-**-**_****
KABA050200LB2L	KABC000300LCA4	KABC-35035L12L	Y9C3602-**-**_****
KABA050200LBA3	KABC004040L42K	KABC-35035L1A3	Y9D1602-**-**_****
KABA050200LBA4	KABC004040L42L	KABC-35035L1A4	Y9E1602-**-**_****
KABA050300LD2K	KABC004040L4A3	UXV1010557010B1	Y9E3602-**-**_****
KABA050300LD2L	KABC004040L4A4	UXV1011057210B1	Y9E560-**-**_****_*****
KABA050300LDA3	KABC004040L52K	UXV1013058510B1	Y9E660-**-**_****_*****
KABA050300LDA4	KABC004040L52L	UXV1014059310B1	Y9TVB2C1E1004CC1*
KABA050400LE2K	KABC004040L5A3	UXV1015056990B1	Y9TVB2C1E1004CC2*
KABA050400LE2L	KABC004040L5A4	UXV3010557010B1	Y9TVB2C1E2010DC1
KABA050400LEA3	KABC030090L72K	UXV3011057210B1	Y9TVB2C1E2010DC2
KABA050400LEA4	KABC030090L72L	UXV3013058510B1	Y9TVB2C1E3020DC1
KABA060500LF2K	KABC030090L7A3	UXV3014059310B1	Y9TVB2C1E3020DC2
KABA060500LF2L	KABC030090L7A4	UXV3015056990B1	Y9TVB2C1E4030DC1
KABA060500LFA3	KABC030110L92K	UXV6010557010B1	Y9TVB2C1E4030DC2
KABA060500LFA4	KABC030110L92L	UXV6011057210B1	Y9TVB2C1E5040DC1
KABA-10040L22K	KABC030110L9A3	UXV6013058510B1	Y9TVB2C1E5040DC2
KABA-10040L22L	KABC030110L9A4	UXV6014059310B1	Y9TVB2C1E7060DC1
KABA-10040L2A3	KABC050200LB2K	UXV6015056990B1	Y9TVB2C1E7060DC2
KABA-10040L2A4	KABC050200LB2L		

Because of permanent improvement of our products, drawings, descriptions, features used on these data sheets are for guidance only and can be modified without prior advice



# Section 4

## Miniature temperature limiters, **wire or cable** electrical connections



Because of permanent improvement of our products, drawings, descriptions, features used on these data sheets are for guidance only and can be modified without prior advice

# Technical introduction on Thermostats for potentially explosive environments

## First part

### Electromechanical thermostats for use in industrial **hazardous** environments. For industrial **non-hazardous** environments **see catalogues 1, 2 and 3**

#### 6 essential requirements for all thermostats on potentially explosives areas

Requirement N°1	Requirement N°2	Requirement N°3
<p><u>Types of explosive zones:</u></p> <ul style="list-style-type: none"> <li>- Zone 0 for gases, (20 for dust): Explosive atmosphere present permanently or for long periods (more than 1000 hours per year), in normal operation. In this area, the danger is permanent, long-term or frequent</li> <li>- Zone 1 for gases, (21 for dust): Explosive atmosphere present occasionally (between 10 and 100 hours per year), in normal operation. In this area, danger is occasional</li> <li>- Zone 2 for gases, (22 for dust): Explosive atmosphere present accidentally in the event of a malfunction or for short periods of time (less than 10 hours per year), in normal operation. In this area, danger is rare.</li> </ul> <p><u>Described by standards: IEC60079-0, GB3836.1</u></p> <p><b>Unless otherwise specified in the technical data sheets, our thermostats are approved for use in zone 1 (11 for dust) and zone 2 (12 for dust)</b></p>	<p><u>Classification of types of gases and explosive dust:</u></p> <p>Electromechanical thermostats are devices that frequently produce sparks between contacts during normal operation. Their design must therefore consider their resistance to an explosion occurring inside their protective envelope, without it being able to propagate outside. The class of resistance to this explosion is dictated by the force of this explosion, which varies depending on the types of gas and dust. Gases are classified according to their increasing explosiveness.</p> <ul style="list-style-type: none"> <li>- Group I: Methane (Usual in mines under the name firedamp)</li> <li>- Group IIA: Propane</li> <li>- Group IIB: Ethylene</li> <li>- Group IIC: Hydrogen and acetylene (the most dangerous)</li> </ul> <p>Dusts are classified as follows:</p> <ul style="list-style-type: none"> <li>- Group IIIA: Lint and combustible wires</li> <li>- Group IIIB: Non-conductive dust</li> <li>- Group IIIC: Conductive dust (the highest protection class)</li> </ul> <p><u>Described by standards: IEC60076-0:15:3, IEC60034-1, and GB3836.1:15:3</u></p> <p><b>Unless otherwise specified in the technical data sheets, our thermostats are approved for use in the presence of hydrogen and acetylene: Group IIC (the highest classification, including all other types of gas) and group IIIC for dust (the highest classification, including electrically conductive dust)</b></p>	<p><u>Equipment Protection Level:</u></p> <p>Because thermostats produce sparks in normal operation, their electrical rating is significant, and internal mechanical movements can occur in normal operation, the authorized protection modes that can be used are limited, these are:</p> <ul style="list-style-type: none"> <li>- Type “d” so-called “explosion-proof” enclosures. These envelopes contain the explosion inside without it being able to propagate outside. The movements of the external measuring elements necessary for the operation of the thermostat are made through very precise wall crossings with very limited gap.</li> <li>- Type “m” enclosures: Contacts which could ignite an explosive atmosphere with sparks are enclosed in a resin in such a way that this explosive atmosphere cannot penetrate and ignite. Only a few miniature thermostats with a fully internal measuring element can use this technique. The exact classification used is “mb” the letter “b” meaning “high protection”, (safe after a malfunction). This “mb” classification authorizes use in mines.</li> </ul> <p>The classification of protective enclosures against explosive dust is classified “t”. The exact classification used is “tb” the letter “b” meaning “high protection, (safe after a malfunction). This “tb” classification authorizes use in mines.</p> <p><u>Described by standards: IEC60079-1; GB3836.1; IEC60079-18; GB/T 3836.9; IEC60079-31; GB/T 3836.31</u></p> <p><b>The technical sheets in this catalogue describe the protection mode used: “db”, “mb” or “tb”</b></p>



# Explosion proof thermostats



Requirement N°4	Requirement N°5	Requirement N°6
<p><u>Connection method and insulation between ground and live conductors.</u></p> <ul style="list-style-type: none"> <li>- In the design of thermostat boxes with “mb” type protection, particular attention is paid by the standards against the risks of electric arcs and the parts of the box connected to ground. This requirement is particularly critical because the additional electrical insulation of the measuring elements, which must be in thermal contact with the walls of the device they control, is a priori incompatible with their correct operation. Only JPCI was able to get around this (patented) obstacle.</li> <li>- For type “d” and “e” enclosures, depending on the enclosure models, the equipotential grounding is external and internal (Aluminum enclosures) or simply internal (PPS enclosures), and its section is 4mm<sup>2</sup> or 6mm<sup>2</sup>.</li> </ul> <p><u>Described by standards: IEC 60079-18.7.5.3; GB GB/T 3836.9:7.5.4; IEC60076-0:15:3, IEC60034-1; GB3836.1:15:3</u></p> <p><b>In this catalogue, all thermostat boxes include one or more grounding terminals, with the exception of miniature thermostats with “mb” protective casing whose small size does not allow a terminal to be incorporated for this purpose, and whose grounding is carried out by fixing their housing to a support.</b></p>	<p><u>Electrical connections to the outside.</u></p> <p>When explosion protection is achieved by the method of construction, thermostats still need to be connected to a power supply and to the device they are to regulate.</p> <p>Traditionally this connection was made inside an explosion-proof box containing a terminal block.</p> <p>The weight and cost of these massive boxes have now made the technique evolve towards thermostats in small boxes with direct outputs by wire, in “d” or “mb” type envelopes, themselves included in light boxes with “e” type increased safety comprising terminal blocks and cable glands. This solution is lighter and more economical.</p> <p>This configuration therefore includes a mixed “d+e” or “mb+e” approval, which is found on a large part of our devices.</p> <p><u>Described by standards: IEC 60079-7; GB/T 3836.3</u></p> <p><b>In this catalogue you will find:</b></p> <ul style="list-style-type: none"> <li>- Thermostats already incorporated in “e” type boxes including a connection terminal block and cable glands for the passage of electrical cables.</li> <li>- Thermostats with a direct electrical output via wires or cables, to be installed or simply connected in a “g” or “e” type box.</li> </ul>	<p><u>Case temperature “T” and ambient temperature “T amb. “. These two parameters should not be confused</u></p> <ul style="list-style-type: none"> <li>- The temperature of the box in normal operation, placed in an environment of 25°C, is given by its self-heating by Joule effect of the internal conductors and contacts. The higher this temperature, the greater the risk of ignition of explosive gases upon contact.</li> </ul> <p>This T classification is given according to the following coding (class, maximum temperature)</p> <p>T1: 450°C T2: 300°C T3: 200°C T4: 135°C T5: 100°C T6: 85°C</p> <p>For thermostats, common T classes are T4, T5, T6. In the case of protection against explosive dust, the temperature is given in °C</p> <ul style="list-style-type: none"> <li>- The ambient temperature is that of the atmosphere around the envelope. In the case of bulb and capillary thermostats, this ambient temperature can modify the calibration of the device. It is also possible that the thermostat measuring element is placed in a location where it measures a temperature higher than the class T of the enclosure (oven, tank, etc.)</li> </ul> <p><u>In the case of thermostats measuring a wall temperature, the limits given by class T must not be exceeded.</u></p> <p><u>Described by standards: IEC 60079-0: 5; GB/T 3836.1: 5.</u></p> <p><b>In the pages of this catalogue, the maximum temperature authorized for the body of the thermostats (Tamb.) is indicated, as well as the maximum temperature on the temperature sensing device (bulb, rod or wall). The T coding (for gases) and the value in °C of the temperature value of the envelope (for dust) appear in its approval. Particular attention must be paid to respecting these values.</b></p>

And many other mandatory rules apply to thermostats: Their electrical rating, their operating voltage, their electrical lifespan etc., according to EN 60730 and UL 60730 standards. As with each requirement of the standards, everything is designed accordingly and carefully verified and tested in our own UL and CE recognized laboratory and by additional certification tests carried out by TÜV and UL.

Because of permanent improvement of our products, drawings, descriptions, features used on these data sheets are for guidance only and can be modified without prior advice

## Miniature current sensing temperature limiters up to 100°C (212°F), surface mounting, cable connection

Electrical connection	Set point adjustment	Mounting	Action	Contact Rating 250V	Min. and max. of calibration	Type
Cable	Fixed setting	Front, 2 holes dia. 3.1mm	Limiter	SPNC, open on rise 6A	5 to +100°C	<b>UZ</b>

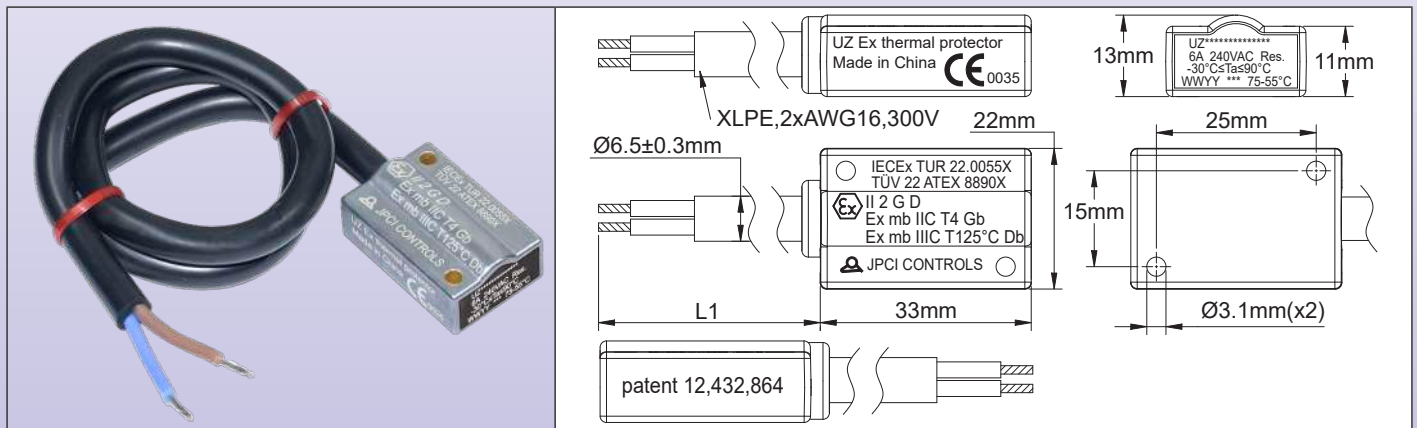

### General rules for installation:

**Important note:** These limiters are intended to control temperatures in gas or dust hazardous areas.  
**For gas hazardous areas,** this equipment is approved as “Ex-mb” and is suitable for use in zone 1 and zone 2, gas group IIC (Hydrogen/Acetylene, the highest protection group), with a temperature classification T4;  
**For dust hazardous areas,** this equipment is approved as “Ex-mb”, suitable for use in, zone 21 and zone 22, the dust group is IIIC (electric conductive dust, the highest protection group), maximum allowed equipment temperature 125°C. The thermostat electrical connections at the end of the wires must be made inside an EX-“e” enclosure.  
**Approvals:** These thermostats are certified: ATEX: TÜV 22 ATEX 8890 X; IECEX: TUR 22.0055X.  
**Patent number:** 102023123053.0

**Housing:** Aluminum, 33 × 13 × 22mm  
**Temperature sensing element:** Current sensitive miniature bimetal disc  
**Electrical connection:** XLPE insulated cable, 2 × AWG16 (≈2 × 1mm<sup>2</sup>), 300V, UL style 4411, withstanding -40+125°C (-40+257°F), Wire ends with crimped terminals.  
**Ground:** By the enclosure body  
**Adjustment:** These limiters are factory calibrated, with no adjustment possible by user. Calibration values are checked on it before encapsulation. **They are checked with a pilot load at nearly 0 Amp.**  
**Mounting:** 2 holes dia 3.1mm 25mm × 15mm distance  
**Response time:** These limiters are not designed to respond quickly if the temperature rise rate is higher than 0.5°C per minute  
**Contacts:** Snap action contact, SPNC, open by temperature rise  
**Electrical rating:** 6A 240V resistive and 3A 240V inductive (10,000 cycles). Suitable for power control, remote control of relay coils or PLCs circuits.  
 These devices use silver contacts or silver alloy contacts. Due to the possible oxidation of the contacts in time, we do not recommend the use of AC or DC low-voltage circuits (24V or less) if the switched intensity is less than 100mA, or the switched power less than 800mW.  
**Expected Short-Circuit Current:** 22.2A.  
**Current derating:** These devices are current sensitives and the real opening temperature must be decreased depending of the current in the circuit where they are used.

Amps	3A	5A	7A
Derating	-2.5°C	-5°C	-10°C

**For example:** A limiter calibrated at 100°C with cut a 90°C if the current is 7Amps

Because of permanent improvement of our products, drawings, descriptions, features used on these data sheets are for guidance only and can be modified without prior advice



**Short circuit trip time:** If for any reason there is an overload in the circuit, the limiter will open automatically. The table hereunder provides the tripping in seconds, depending of the overload. Measurement made with a thermostat at 25°C (77°F) ambient temperature

	15A	20A	25A	30A	35A	40A
<b>Calibration at 100°C</b>	100s	30s	11s	5s	2.5s	1s

**Classification:**

Gas: II 2G Ex mb IIC T4 Gb

Dust: II 2D Ex mb IIIC T125°C Db



### Main part numbers

Open temperature ±5°C, (±9°F)	Close temperature ±5°C, (±9°F)	Part numbers with 1m long cable (L1)	Part numbers with 3m long cable (L1)	Part numbers with 6m long cable (L1)
50°C (122°F)	38°C (100°F)	UZV1005053810B1	UZV3005053810B1	UZV6005053810B1
70°C (158°F)	50°C (122°F)	UZV1007055010B1	UZV3007055010B1	UZV6007055010B1
80°C (176°F)	57°C (135°F)	UZV1008055710B1	UZV3008055710B1	UZV6008055710B1
100°C (212°F)	67°C (153°F)	UZV1010056710B1	UZV3010056710B1	UZV6010056710B1

Because of permanent improvement of our products, drawings, descriptions, features used on these data sheets are for guidance only and can be modified without prior advice

Because of permanent improvement of our products, drawings, descriptions, features used on these data sheets are for guidance only and can be modified without prior advice

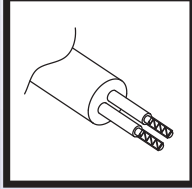
## Current sensing miniature temperature limiters, calibration up to 130°C (266°F), surface mounting, cable connection

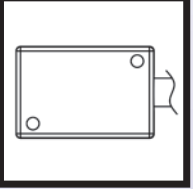
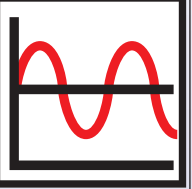
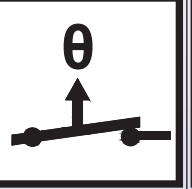
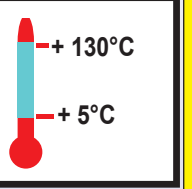
Electrical connection	Set point adjustment	Mounting	Action	Contact Rating 250V	Min. and max. of calibration	Type
Cable	Fixed setting	Front, 2 holes dia. 3.1mm	Limiter	SPNC, open on rise 6A	5 to +130°C	<b>UX</b>
						

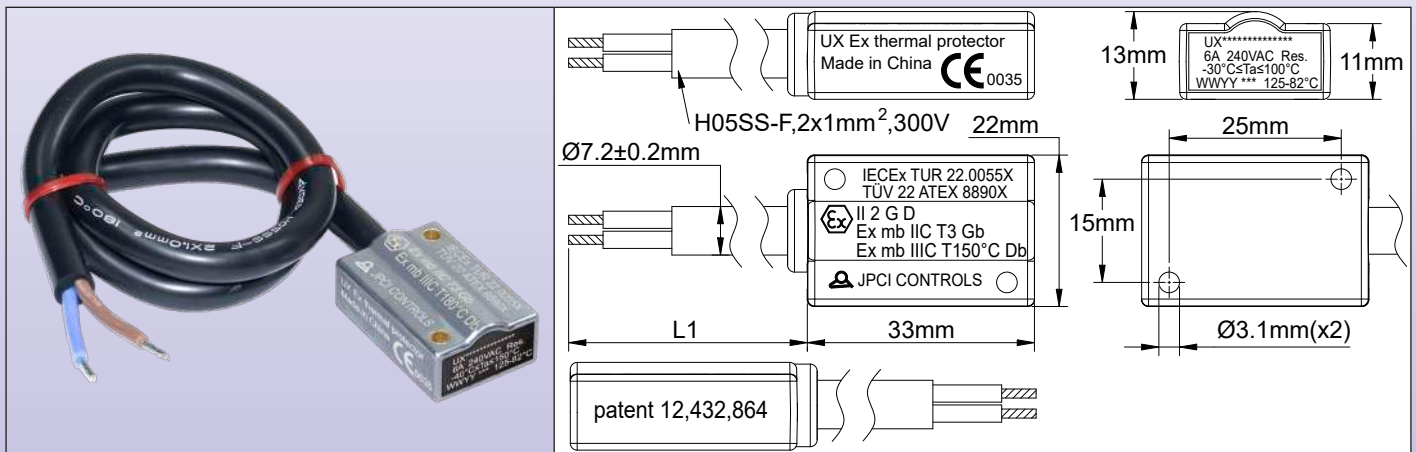

### General rules for installation:

**Important note:** These limiters are intended to control temperatures in gas or dust hazardous areas.  
**For gas hazardous areas,** this equipment is approved as “Ex-mb” and is suitable for use in zone 1 and zone 2, gas group IIC (Hydrogen/Acetylene, the highest protection group), with a temperature classification T3;  
**For dust hazardous areas,** this equipment is approved as “Ex-mb”, suitable for use in, zone 21 and zone 22, the dust group is IIIC (electric conductive dust, the highest protection group), maximum allowed equipment temperature 150°C. The thermostat electrical connections at the end of the wires must be made inside an EX-“e” enclosure.  
**Approvals:** These thermostats are certified: ATEX: TÜV 22 ATEX 8890 X; IECEx: TUR 22. 0055X .  
**Patent number:** 102023123053.0

**Housing:** Aluminum, 33 × 13 × 22mm  
**Temperature sensing element:** Current sensitive miniature bimetal disc  
**Electrical connection:** H05SS-F silicone insulated cable, 2 × 1mm<sup>2</sup> (≈ 2 × AWG16), 300V, withstanding -60+180°C (-76+356°F). Wire ends with crimped terminals.  
**Ground:** By the enclosure body  
**Adjustment:** These limiters are factory calibrated, with no adjustment possible by user. Calibration values are checked on it before encapsulation. They are checked with a pilot load at nearly 0 Amp.  
**Mounting:** 2 holes dia 3.1mm 25mm × 15mm distance  
**Response time:** These limiters are not designed to respond quickly if the temperature rise rate is higher than 0.5°C per minute  
**Contacts:** Snap action contact, SPNC, open by temperature rise  
**Electrical rating:** 6A 240V resistive and 3A 240V inductive (10,000 cycles). Suitable for power control, remote control of relay coils or PLCs circuits.  
 These devices use silver contacts or silver alloy contacts. Due to the possible oxidation of the contacts in time, we do not recommend the use of AC or DC low-voltage circuits (24V or less) if the switched intensity is less than 100mA, or the switched power less than 800mW.  
**Expected Short-Circuit Current:** 22.2A.  
**Current derating:** These devices are current sensitives and the real opening temperature must be decreased depending of the current in the circuit where they are used.

Amps	3A	5A	7A
Derating	-2.5°C	-5°C	-10°C

**For example:** A limiter calibrated at 100°C with cut a 90°C if the current is 7Amps



**Short circuit trip time:** If for any reason there is an overload in the circuit, the limiter will open automatically. The table hereunder provides the tripping in seconds, depending of the overload. Measurement made with a thermostat at 25°C (77°F) ambient temperature

	15A	20A	25A	30A	35A	40A
Calibration at 100°C	100s	30s	11s	5s	2.5s	1s
Calibration at 110°C	150s	40s	20s	8s	4s	2.5s
Calibration at 150°C	400s	150s	45s	18s	9s	6s

**Classification:**

Gas: II 2G Ex mb IIC T3 Gb

Dust: II 2D Ex mb IIIC T150°C Db

### Main part numbers

Open temperature ±5°C, (±9°F)	Close temperature ±5°C, (±9°F)	Part numbers with 1m long cable (L1)	Part numbers with 3m long cable (L1)	Part numbers with 6m long cable (L1)
105°C (221°F)	70°C (122°F)	UXV1010557010B1	UXV3010557010B1	UXV6010557010B1
110°C (230°F)	72°C (162°F)	UXV1011057210B1	UXV3011057210B1	UXV6011057210B1
130°C (266°F)	85°C (185°F)	UXV1013058510B1	UXV3013058510B1	UXV6013058510B1
140°C (284°F)	93°C (199°F)	UXV1014059310B1	UXV3014059310B1	UXV6014059310B1
150°C (302°F)	100°C (212°F)	UXV1015056990B1	UXV3015056990B1	UXV6015056990B1

Because of permanent improvement of our products, drawings, descriptions, features used on these data sheets are for guidance only and can be modified without prior advice

Because of permanent improvement of our products, drawings, descriptions, features used on these data sheets are for guidance only and can be modified without prior advice

**Miniature temperature limiters, not current sensing, calibration up to 85°C (185°F), wires connection to use when R290 highly flammable refrigerant classed A3 upon ISO 817 may be present.**

**This is not a Ex certified product**

Electrical connection	Set point adjustment	Mounting	Action	Contact Rating 250V AC	Min. and max. of calibration	Type
Wires	Fixed setting	On or through wall	Limiter	Open on temperature rise 5A	+5 to +85°C	<b>4YC</b>

**General rules for installation:**

**Important note:** Limiter designed to comply with IEC 60079-0: 2017 (Explosive atmospheres, general requirements), § 26.5.1.2 and IEC 60079-15: 2017 (Explosive atmospheres, Equipment protection by type of protection “n”) § 9; 11.2.1; 11.2.2; and 11.2.3.1, when R290 highly flammable refrigerant classed A3 upon ISO 817, as found in air conditioning and heat pumps, may be present (See IEC/EN60335-2-40)

**Approval:** TÜV Test report CL 50664237 0001

**Housing:** IP65 aluminum, epoxy potted, many different dimensions, see drawings

**Temperature sensing element:** Miniature bimetal disc, **not current sensitive**

**Electrical connection:** Two PVC insulated wires, 0.75mm<sup>2</sup>, T105°C (221°F). H05VVf 300V/500V. Wire ends with crimped terminals.

**Ground:** By the enclosure body

**Adjustment:** These limiters are factory calibrated, with no adjustment possible by user. Calibration values are checked on it before encapsulation.

**Mounting:** Surface or through wall

**Response time:** These limiters are not designed to respond quickly if the temperature rise rate is higher than 1°C per minute.

**Contacts:** Single pole snap action contact, open by temperature rise

**Electrical rating:** 5A 250V resistive (100,000 cycles). Suitable for power control, remote control of relay coils or PLCs circuits.

**Option:** On request rating up to 9A 250V with 1.5mm<sup>2</sup> wires (Need certification testing)

**Main part numbers**

Open temperature ±5°C, (±9°F)	Close temperature ±5°C, (±9°F)	Part numbers with 1m long wires (L1)	Part numbers with 3m long wires (L1)	Part numbers with 6m long wires (L1)
50°C (122°F)	40°C (100°F)	4YC1A10*OF5040D0	4YC1A30*OF5040D0	4YC1A60*OF5040D0
70°C (158°F)	60°C (122°F)	4YC1A10*OF7060D0	4YC1A30*OF7060D0	4YC1A60*OF7060D0
75°C (167°F)	65°C (149°F)	4YC1A10*OF7565D0	4YC1A30*OF7565D0	4YC1A60*OF7565D0
80°C (176°F)	70°C (158°F)	4YC1A10*OF8070D0	4YC1A30*OF8070D0	4YC1A60*OF8070D0
85°C (185°F)	75°C (167°F)	4YC1A10*OF8575D0	4YC1A30*OF8575D0	4YC1A60*OF8575D0

\*: Use the body letter (C, D, E, F) described in drawings. For body letter E the exact reference (E0, E8, EA, EB) depends of mounting diameter



## Miniature temperature limiters, not current sensing, calibration up to 100°C (212°F), cable or wires connection

Electrical connection	Set point adjustment	Mounting	Action	Contact Rating 240V	Min. and max. of calibration	Types
Cable or wires	Fixed setting	On or through wall	Limiter	Open on temperature rise 10A	5 to +100°C	<b>4VA</b> <b>4VB</b>

**4VA main types with cable**

**4VB main types with wires**

### General rules for installation:

**Important note:** These limiters are intended to monitor or control temperatures in gas or dust hazardous areas. For gas hazardous areas, this equipment is approved as “Ex-mb” and is suitable for use in zone 1 and zone 2, gas group IIC (Hydrogen/Acetylene, the highest protection group), with a temperature classification T4;

Because of permanent improvement of our products, drawings, descriptions, features used on these data sheets are for guidance only and can be modified without prior advice

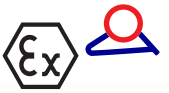

Because of permanent improvement of our products, drawings, descriptions, features used on these data sheets are for guidance only and can be modified without prior advice

**For dust hazardous areas**, this equipment is approved as “Ex-mb”, suitable for use in, zone 21 and zone 22, the dust group is IIIC (electric conductive dust, the highest protection group), maximum allowed equipment temperature **125°C**. The thermostat electrical connections at the end of the wires must be made inside an EX-“e” enclosure.

**Approvals:** These thermostats are certified: ATEX: TÜV 22 ATEX 8891 X; IECEx: TUR 22.0056X.

**Housing:** IP65 Anodized aluminum, epoxy potted, many different dimensions, see drawings

**Temperature sensing element:** Miniature bimetal disc, **not current sensitive**

**Electrical connection:**

- **4VA:** XLPE insulated cable, 2 × AWG16 (≈2 × 1.25mm<sup>2</sup>), 300V, UL style 4441, withstanding -40+125°C (-40+257°F),

- **4VB:** Two XLPE insulated wires, AWG16 (≈ 1.25mm<sup>2</sup>), 300V, withstanding -40+125°C (-40+257°F),

Wire ends with crimped terminals. Other lengths on request.

**Ground:** By the enclosure body

**Adjustment:** These limiters are factory calibrated, with no adjustment possible by user. Calibration values are checked on it before encapsulation.

**Mounting:** Surface or through wall

**Response time:** These limiters are not designed to respond quickly if the temperature rise rate is higher than 0.5°C per minute

**Contacts:** Single pole snap action contact, open by temperature rise

**Electrical rating:** 10A 240V resistive (30,000cycles) and 8A 240V inductive (6,000 cycles). Suitable for power control, remote control of relay coils or PLCs circuits.

These devices use silver contacts or silver alloy contacts. Due to the possible oxidation of the contacts in time, we do not recommend the use of AC or DC low-voltage circuits (24V or less) if the switched intensity is less than 100mA, or the switched power less than 800mW.

**Expected Short-Circuit Current:** 15A.

**Classification:**

Gas: Ⓜ II 2G Ex mb IIC T4 Gb

Dust: Ⓜ II 2D Ex mb IIIC T125°C Db

## Main part numbers with cable output

Open temperature ±5°C, (±9°F)	Close temperature ±5°C, (±9°F)	Part numbers with 1m long cable (L1)	Part numbers with 3m long cable (L1)	Part numbers with 6m long cable (L1)
50°C (122°F)	40°C (100°F)	4VA1A00*005040D0	4VA1A30*005040D0	4VA1A60*005040D0
70°C (158°F)	60°C (122°F)	4VA1A00*007060D0	4VA1A30*007060D0	4VA1A60*007060D0
80°C (176°F)	70°C (135°F)	4VA1A00*008070D0	4VA1A30*008070D0	4VA1A60*008070D0
100°C (212°F)	90°C (153°F)	4VA1A00*00A090D0	4VA1A30*00A090D0	4VA1A60*00A090D0

## Main part numbers with 2 wires output

Open temperature ±5°C, (±9°F)	Close temperature ±5°C, (±9°F)	Part numbers with 1m long cable (L1)	Part numbers with 3m long cable (L1)	Part numbers with 6m long cable (L1)
50°C (122°F)	40°C (100°F)	4VB1A00*005040D0	4VB1A30*005040D0	4VB1A60*005040D0
70°C (158°F)	60°C (122°F)	4VB1A00*007060D0	4VB1A30*007060D0	4VB1A60*007060D0
80°C (176°F)	70°C (135°F)	4VB1A00*008070D0	4VB1A30*008070D0	4VB1A60*008070D0
100°C (212°F)	90°C (153°F)	4VB1A00*00A090D0	4VB1A30*00A090D0	4VB1A60*00A090D0

\*: Use the body letter (A, B, D, E) described in drawings. For body letter C the exact reference (C0, C8, CA, CB) depends of mounting diameter



## Miniature temperature limiters, not current sensing, calibration up to 130°C (266°F), cable or wires connection

Electrical connection	Set point adjustment	Mounting	Action	Contact Rating 240V	Min. and max. of calibration	Types
Cable or wires	Fixed setting	On or through wall	Limiter	Open on temperature rise, 10A	5 to +130°C	<b>4XA</b> <b>4XB</b>

**A** **B** **C**  
**D** **E** **F**

**A** **B** **C**  
**D** **E** **F**

4XA main types with cable

**A** **B** **C**  
**D** **E** **F**

**A** **B** **C**  
**D** **E** **F**

4XB main types with wires

### General rules for installation:

**Important note:** These limiters are intended to monitor or control temperatures in gas or dust hazardous areas. For gas hazardous areas, this equipment is approved as "Ex-mb" and is suitable for use in zone 1 and zone 2, gas group IIC (Hydrogen/Acetylene, the highest protection group), with a temperature classification T3;

Because of permanent improvement of our products, drawings, descriptions, features used on these data sheets are for guidance only and can be modified without prior advice

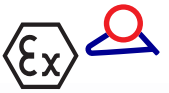

Because of permanent improvement of our products, drawings, descriptions, features used on these data sheets are for guidance only and can be modified without prior advice

**For dust hazardous areas**, this equipment is approved as “Ex-mb”, suitable for use in, zone 21 and zone 22, the dust group is IIIC (electric conductive dust, the highest protection group), maximum allowed equipment temperature **150°C**. The thermostat electrical connections at the end of the wires must be made inside an EX-“e” enclosure.

**Approvals:** These thermostats are certified: ATEX: TÜV 22 ATEX 8891 X; IECEx: TUR 22.0056X .

**Housing:** IP65 Anodized aluminum, silicone potted, many different dimensions, see drawings

**Temperature sensing element:** Miniature bimetal disc, **not current sensitive**

**Electrical connection:**

- **4XA:** Silicone insulated cable, (H05SS-F), 2 × 1.5mm<sup>2</sup> (≈ 2 × AWG16), 300V, withstanding -60+180°C (-76+356°F).

- **4XB:** Two silicone insulated wires, 1.5mm<sup>2</sup> (≈ AWG16), 300V, withstanding -60+180°C (-76+356°F).

Wire ends with crimped terminals. Other lengths on request.

**Ground:** By the enclosure body

**Adjustment:** These limiters are factory calibrated, with no adjustment possible by user. Calibration values are checked on it before encapsulation.

**Mounting:** Surface or through wall

**Response time:** These limiters are not designed to respond quickly if the temperature rise rate is higher than 0.5°C per minute.

**Contacts:** Single pole snap action contact, open by temperature rise

**Electrical rating:** 10A 240V resistive (30,000cycles) and 8A 240V inductive (6,000 cycles). Suitable for power control, remote control of relay coils or PLCs circuits.

These devices use silver contacts or silver alloy contacts. Due to the possible oxidation of the contacts in time, we do not recommend the use of AC or DC low-voltage circuits (24V or less) if the switched intensity is less than 100mA, or the switched power less than 800mW.

**Expected Short-Circuit Current:** 15A.

**Classification:**

Gas: II 2G Ex mb IIC T3 Gb

Dust: II 2D Ex mb IIIC T150°C Db

## Main part numbers with cable output

Open temperature ±5°C, (±9°F)	Close temperature ±5°C, (±9°F)	Part numbers with 1m long cable (L1)	Part numbers with 3m long cable (L1)	Part numbers with 6m long cable (L1)
105°C (221°F)	95°C (203°F)	4XA1A00*00A595D0	4XA1A30*00A595D0	4XA1A60*00A595D0
110°C (230°F)	100°C (212°F)	4XA1A00*00B0A0D0	4XA1A30*00B0A0D0	4XA1A60*00B0A0D0
130°C (266°F)	120°C (248°F)	4XA1A00*00D0C0D0	4XA1A30*00D0C0D0	4XA1A60*00D0C0D0
140°C (284°F)	130°C (266°F)	4XA1A00*00E0D0D0	4XA1A30*00E0D0D0	4XA1A60*00E0F0D0
150°C (302°F)	140°C (284°F)	4XA1A00*00G0F0D0	4XA1A30*00G0F0D0	4XA1A60*00G0F0D0

## Main part numbers with 2 wires output

Open temperature ±5°C, (±9°F)	Close temperature ±5°C, (±9°F)	Part numbers with 1m long cable (L1)	Part numbers with 3m long cable (L1)	Part numbers with 6m long cable (L1)
105°C (221°F)	95°C (203°F)	4XB1A00*00A595D0	4XB1A30*00A595D0	4XB1A60*00A595D0
110°C (230°F)	100°C (212°F)	4XB1A00*00B0A0D0	4XB1A30*00B0A0D0	4XB1A60*00B0A0D0
130°C (266°F)	120°C (248°F)	4XB1A00*00D0C0D0	4XB1A30*00D0C0D0	4XB1A60*00D0C0D0
140°C (284°F)	130°C (266°F)	4XB1A00*00E0D0D0	4XB1A30*00E0D0D0	4XB1A60*00E0D0D0
150°C (302°F)	140°C (284°F)	4XB1A00*00G0F0D0	4XB1A30*00G0F0D0	4XB1A60*00G0F0D0

\*: Use the body letter (A, B, D, E) described in drawings. For body letter C the exact reference (C0, C8, CA, CB) depends of mounting diameter



Because of permanent improvement of our products, drawings, descriptions, features used on these data sheets are for guidance only and can be modified without prior advice



# Section 5

## Thermostats and limiters with bulb and capillary sensing element, **wires or cable** electrical connection



Because of permanent improvement of our products, drawings, descriptions, features used on these data sheets are for guidance only and can be modified without prior advice

## Temperature control, front or rear mounting, wire connection

Electrical connection	Set point adjustment	Mounting	Action	Contact Rating	T° ranges min and max adjustment limits	Types
Wire	- 10mm shaft - Screwdriver on dial - Fixed setting	Front mounting with 2 M4 screws or Rear mounting with 2 M4 screws	Control	SPDT 16(4)A, 400VAC 25(4)A, 250VAC	-50 to + 500°C	<b>KAB-K</b>

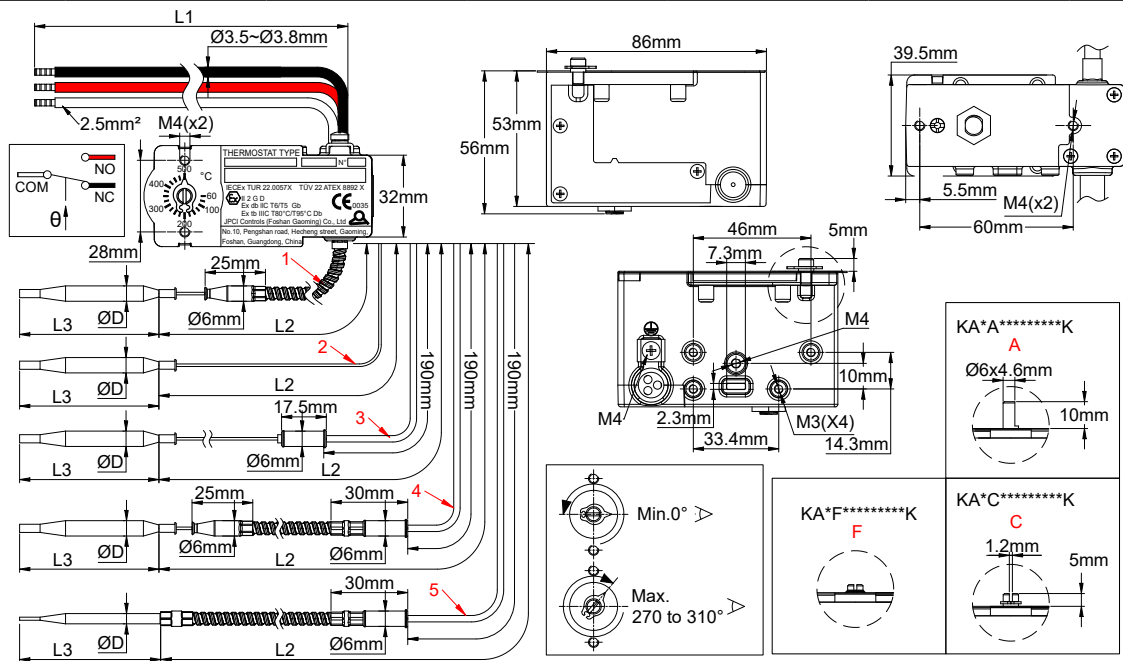
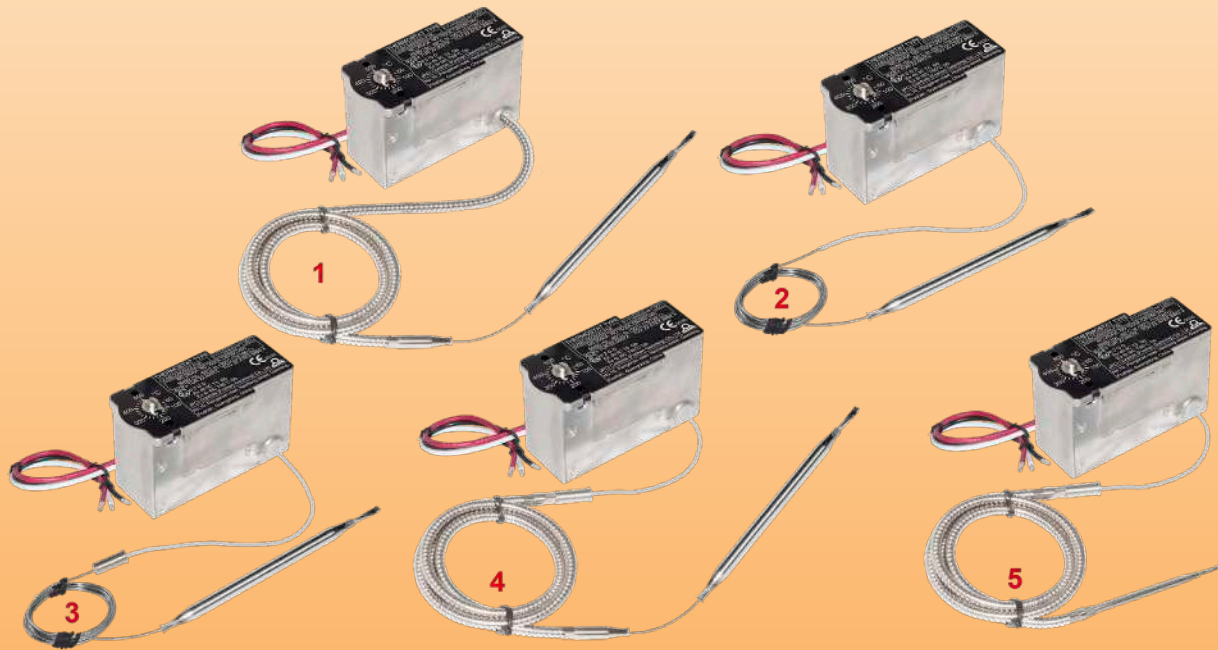

Because of permanent improvement of our products, drawings, descriptions, features used on these data sheets are for guidance only and can be modified without prior advice



## Types of capillary outputs

- 1: Capillary protected by a flexible stainless steel metal sheath over its entire length, right out of the thermostat body. The 6mm dia. end of the stainless-steel protective sheath is rounded to avoid shearing of the capillary, and the 6mm diameter allows the mounting of accessories such as flange or thermowell (Patented). **This is the capillary protection recommended for thermostats with cable connection.**
- 2: Bare 1mm capillary without any protection.
- 3: Capillary comprising a 6mm diameter brazed fitting allowing an EX “e” box outlet via a cable gland with a 6mm passage. The part of the capillary located inside the EX “e” box is protected against the risks of electrical contact by a PTFE sheath, and the external part is bare.
- 4: Capillary comprising a 6mm diameter brazed fitting allowing an EX “e” box outlet via a cable gland with a 6mm passage. The part of the capillary located inside the EX “e” housing is protected against the risks of electrical contact by a PTFE sheath, and the external part by a flexible metal sheath in stainless steel. The 6mm dia. end of the stainless- steel protective sheath is rounded to avoid shearing of the capillary, and the 6mm diameter allows the mounting of accessories such as flange or thermowell (Patented). **This is the capillary protection recommended for thermostats with EX “e” box.**
- 5: Capillary comprising a 6mm diameter brazed fitting allowing an EX “e” box outlet via a cable gland with a 6mm passage. The part of the capillary located inside the EX “e” housing is protected against the risks of electrical contact by a PTFE sheath, and the external part by a flexible metal sheath in stainless steel. The end of the stainless-steel protective sheath is connected with the bulb to avoid exposure of the capillary. **This is the capillary protection providing the strongest mechanical strenght.**



**A:** Shaft dia. 6mm, length 10mm, for use with printed knobs and bezels, or small plastic arrow knob (available as accessories below);

**C:** Screw driver type, with arrow and printed aluminum dial, for use in PPS Ex-e enclosure of JPCI or other suppliers for heat tracing;

**F:** Fixed and sealed temperature adjustment

## General rules for installation:

**Important note:** These thermostats are intended to monitor or control temperatures in gas or dust hazardous areas.

**For gas hazardous areas,** this equipment is approved as “Ex db” and is suitable for use in zone 1 and zone 2, gas group IIC (Hydrogen/Acetylene, the highest protection group), with a temperature classification T5/ T6;

**For dust hazardous areas,** this equipment is approved as “Ex tb”, suitable for use in zone 21 and zone 22, the dust group is IIIC (electric conductive dust, the highest protection group).

The applicable ambient temperature of the equipment is:

NC: 16(4)A NO: 10(2)A, 125/250/400 VAC; 50/60 Hz; -60°C to +50°C (T6/T80°C)

NC: 16(4)A NO: 10(2)A, 125/250/400 VAC; 50/60 Hz; -60°C to +80°C (T5/T95°C)

NC: 25(4)A NO: 15(2)A, 125/250 VAC; 50/60 Hz; -60°C to +50°C (T5/T95°C)

The thermostat body must be mounted in an explosion-proof box and we preferably recommend an “Ex e” increased safety box, respecting the integrity of the “db” and “tb” regulations.

The outlet of the capillary from this box must be carried out by a cable gland with a gasket adapted to the 6mm diameter of the capillary connection fitting and providing the degree of protection required by the standard.

The models with screw driver adjustment and front mounting allow incorporation inside most existing “Ex e” junction boxes in aluminum or polyester and having inside a free height of 60mm minimum.

With an adjustment per 10mm shaft and printed knob, this minimum height is about 70mm. We recommend checking this height by requesting plans for the devices with the knob of your choice.

**Approvals:** These thermostats are certified:

ATEX: TÜV 22 ATEX 8892 X; IECEx: IECEx TUR 22. 0057 X. CCC: 2025012304765427

**Housing:** aluminum, 86 × 40 × 56mm (Dimensions without shaft and knob)

**Bulb and capillary:** Stainless steel. Standard capillary length 1500mm. (Other lengths available with M.O.Q). Capillary minimum bending radius 5mm.

**Temperature sensing element:** Oil or liquid metalloids filled bulb and capillary.

**Electrical connection:** Silicone insulated wire H05S-K, 2.5mm<sup>2</sup>, T180°C, 450V, standard length 200mm. Wire ends with crimped terminals. Other lengths on request.

**Ground terminals:** one M4 grounding terminals with saddle is located on the wire exit side.

**Special items:** The lateral wire exit face has two M3 threads allowing 4mm<sup>2</sup> or 6mm<sup>2</sup> JPCI ATEX EX-e terminal blocks to

Because of permanent improvement of our products, drawings, descriptions, features used on these data sheets are for guidance only and can be modified without prior advice

be mounted, two more M3 threads for direct mounting of 15mm or 35mm Din rails, and one M4 thread allowing an additional earth terminal block.

**Mounting:** Front bracket with 2 × M4 threads, 28mm distance, or backside by two M4 screws with 60mm distance

**Contacts:** SPDT, snap action contact. Electrical life 100,000 cycles.

**Electrical rating:** Suitable for power control, remote control of relay coils or PLCs circuits.

Voltage	Maximum rating (A) between:	
	Common (white) and normally closed (black)	Common (white) and normally open (red)
400V AC	16 (4)	10(2)
250V AC	25 (4)	15(2)
125V AC	25 (4)	15(2)

These devices use silver contacts or silver alloy contacts. Due to the possible oxidation of the contacts in time, we do not recommend the use of AC or DC low-voltage circuits (24V or less) if the switched intensity is less than 100mA, or the switched power less than 800mW. Contact us for those applications that require gold-plated contacts. The electrical ratings given are normalized resistive circuit values.

**Options:**

- Capillary sleeved with 6mm diameter stainless steel flexible tube
- Capillary with fitting for 6mm cable gland gasket, with or without capillary sleeving in stainless steel

**Mechanical life:** > 500.000 cycles

**Classification:**

Gas: Ex II 2G Ex db IIC T5/T6 Gb

Dust: Ex II 2D Ex tb IIIC T95°C/T80°C Db

## Main references with 200mm wire length (L1)\*\* and capillary output type 4

References with screw driver with arrow adjustment shaft	References with 10mm adjustment shaft	Temperature range	Capillary length (L2, mm)	Bulb diameter (D, mm)	Bulb length (L3, mm)	Differential (°C)	Max temperature on bulb
KABC-35035L12K	KABA-35035L12K	-35~35°C (-31~95°F)	1500	6	100	3.5±1	60°C (140°F)
KABC-10040L22K	KABA-10040L22K	-10~40°C (-14~104°F)	1500	6	130	2.5±1	70°C (158°F)
KABC-20050L32K	KABA-20050L32K	-20~50°C (-4~122°F) *	1500	6	90	3.5±1	80°C (176°F)
KABC004040L42K	KABA004040L42K	4~40°C (39.2~104°F)	1500	6	140	2±1	70°C (158°F)
KABC004040L52K	KABA004040L52K	4~40°C (39.2~104°F)	1500	8	80	2±1	70°C (158°F)
KABC000060L62K	KABA000060L62K	0~60°C (32~140°F)	1500	6	115	3±1	90°C (194°F)
KABC030090L72K	KABA030090L72K	30~90°C (86~194°F)	1500	6	110	3±1	120°C (248°F)
KABC000100L82K	KABA000100L82K	0~100°C (32~212°F)	1500	6	80	5±1.5	130°C (266°F)
KABC030110L92K	KABA030110L92K	30~110°C (86~230°F)	1500	6	85	4±1.5	140°C (284°F)
KABC000200LA2K	KABA000200LA2K	0~200°C (32~392°F)	1500	4	100	10±3	230°C (446°F)
KABC050200LB2K	KABA050200LB2K	50~200°C (122~392°F)	1500	4	120	7.5±2.5	230°C (446°F)
KABC000300LC2K	KABA000300LC2K	0~300°C (32~570°F)	1500	4	70	15±5	330°C (626°F)
KABC050300LD2K	KABA050300LD2K	50~300°C (122~572°F)	1500	4	80	12±4	330°C (626°F)
KABC050400LE2K	KABA050400LE2K	50~400°C (122~752°F)	1500	4	50	18±6	430°C (806°F)
KABC060500LF2K	KABA060500LF2K	60~500°C (140~932°F)	1500	4	120	22±8	530°C (986°F)

\* The filling liquid of these thermostatic assemblies has a freezing temperature of about -50°C (-58°F). However it is important to protect the bulb and /or the capillary against the risk of freezing if a temperature below -35°C (-31°F) can be reached in operation. Acceptable storage temperature: -50°C (-58°F).

\*\* For a longer wire, replace the 13th character (2) by 3 for 30cm, 4 for 40cm, 5 for 50cm a.s.o. For a type 1 capillary outlet: replace the 11th character (L) with G; For a type 2 capillary outlet: replace the 11th character (L) with C; For a type 3 capillary outlet: replace the 11th character (L) with P. For a type 5 capillary outlet: replace the 11th character (L) with T.

Because of permanent improvement of our products, drawings, descriptions, features used on these data sheets are for guidance only and can be modified without prior advice



## Accessories (to be ordered separately)

Dia 40mm printed knob*	Bezel for 40mm knob*	Miniature arrow knob*	Pipe liner crossing flange	Bulb fixing profile on pipes
This knob is printed according to the temperature range of the thermostat. Available in °C or °F. It is used when the thermostat is mounted from the front, with the adjustment shaft passing through the mounting board.	Allows the positioning of the temperature mark on the knob.	To be mounted on the thermostat when it is fixed from the rear in an enclosure. Its size is greater than the arrow used with screwdriver adjustment.	This flange makes it possible to pass through the protective metal sheath located around the thermal insulation of the pipes, without risk of breaking the capillary. It is tightened by a bicone on the 6mm dia. end of the stainless-steel sheathing of the capillary	This profile makes it possible to securely fix with two clamps a thermostat bulb in contact with the wall of a pipe
<b>66MZ</b>	<b>66EN1</b>	<b>66MQ</b>	<b>66KAMB35356</b>	<b>6YTPF160032</b>

This accessory allows to directly mount commercial ATEX terminal blocks designed for 15mmx5.5mm rail (according to IEC60715) on the body of the KA thermostat.	This accessory allows to directly mount commercial ATEX terminal blocks designed for 35mmx7.5mm rail (according to IEC60715) on the body of the KA thermostat. It can be mounted at 2 different levels <b>Attention, this accessory cannot be used on KAB-L</b>	This spring is mounted by screwing onto the capillary between the thermostat bulb and the stainless-steel protective sheath capillary outlets of models 1 or 4, and pushes the bulb into the bottom of the thermowell	Intended for mounting the thermostat bulb for controlling the temperature of liquid tanks
<b>66KA1560</b>	<b>66KA3560</b>	<b>66KARE570</b>	References vary depending of thread and length. Ask us

\* Many other knobs and bezels are described in our catalogue N°1.

## Examples of special customer and sub-assemblies (requesting additional EX approval)

KA with special mounting board for incorporation inside customer enclosure, with 6mm <sup>2</sup> ATEX connection blocks supplied by customer	KA with standard mounting board for incorporation inside JPCI round plastic enclosure Y92, with ATEX 4mm <sup>2</sup> JPCI connection blocks	KA with standard mounting board for incorporation inside JPCI rectangular aluminium enclosure Y97, with ATEX 4mm <sup>2</sup> JPCI connection blocks	KA with standard 15mm Din rail mounted on the side, with 4mm <sup>2</sup> ATEX connection blocks supplied by customer





## Types of capillary outputs

- 1: Capillary protected by a flexible stainless steel metal sheath over its entire length, right out of the thermostat body. The 6mm dia. end of the stainless-steel protective sheath is rounded to avoid shearing of the capillary, and the 6mm diameter allows the mounting of accessories such as flange or thermowell (Patented). **This is the capillary protection recommended for thermostats with cable connection.**
- 2: Bare 1mm capillary without any protection.
- 3: Capillary comprising a 6mm diameter brazed fitting allowing an EX “e” box outlet via a cable gland with a 6mm passage. The part of the capillary located inside the EX “e” box is protected against the risks of electrical contact by a PTFE sheath, and the external part is bare.
- 4: Capillary comprising a 6mm diameter brazed fitting allowing an EX “e” box outlet via a cable gland with a 6mm passage. The part of the capillary located inside the EX “e” housing is protected against the risks of electrical contact by a PTFE sheath, and the external part by a flexible metal sheath in stainless steel. The 6mm dia. end of the stainless- steel protective sheath is rounded to avoid shearing of the capillary, and the 6mm diameter allows the mounting of accessories such as flange or thermowell (Patented). **This is the capillary protection recommended for thermostats with EX “e” box.**
- 5: Capillary comprising a 6mm diameter brazed fitting allowing an EX “e” box outlet via a cable gland with a 6mm passage. The part of the capillary located inside the EX “e” housing is protected against the risks of electrical contact by a PTFE sheath, and the external part by a flexible metal sheath in stainless steel. The end of the stainless-steel protective sheath is connected with the bulb to avoid exposure of the capillary. **This is the capillary protection providing the strongest mechanical strenght.**



A: Shaft dia. 6mm, length 10mm, for use with printed knobs and bezels, or small plastic arrow knob (available as accessories below);



C: Screw driver type, with arrow and printed aluminum dial, for use in PPS Ex-e enclosure of JPCI or other suppliers for heat tracing;



F: Fixed and sealed temperature adjustment

## General rules for installation:

**Important note:** These thermostats are intended to monitor or control temperatures in gas or dust hazardous areas.

**For gas hazardous areas,** this equipment is approved as “Ex db” and is suitable for use in zone 1 and zone 2, gas group IIC (Hydrogen/Acetylene, the highest protection group), with a temperature classification T5/ T6;

**For dust hazardous areas,** this equipment is approved as “Ex tb”, suitable for use in zone 21 and zone 22, the dust group is IIIC (electric conductive dust, the highest protection group).

The applicable ambient temperature of the equipment is:

NC: 16(4)A NO: 10(2)A, 125/250/400 VAC; 50/60 Hz; -60°C to +50°C (T6/T80°C)

NC: 16(4)A NO: 10(2)A, 125/250/400 VAC; 50/60 Hz; -60°C to +80°C (T5/T95°C)

NC: 25(4)A NO: 15(2)A, 125/250 VAC; 50/60 Hz; -60°C to +50°C (T5/T95°C)

The thermostat body must be mounted in an explosion-proof box and we preferably recommend an “Ex e” increased safety box, respecting the integrity of the “db” and “tb” regulations.

The outlet of the capillary from this box must be carried out by a cable gland with a gasket adapted to the 6mm diameter of the capillary connection fitting and providing the degree of protection required by the standard.

The models with screw driver adjustment and front mounting allow incorporation inside most existing “Ex e” junction boxes in aluminum or polyester and having inside a free height of 65mm minimum upside the DIN rail

With an adjustment per 10mm shaft and printed knob, this minimum height is about 75mm. We recommend checking this height by requesting plans for the devices with the knob of your choice.

**Approvals:** These thermostats are certified:

ATEX: TÜV 22 ATEX 8892 X; IECEx: IECEx TUR 22. 0057 X. CCC: 2025012304765427

**Housing:** Aluminum, 86 × 40 × 64mm (Dimensions without shaft and knob)

**Bulb and capillary:** Stainless steel. Standard capillary length 1500mm. (Other lengths available with M.O.Q) Capillary minimum bending radius 5mm.

**Temperature sensing element:** Oil or liquid metalloids filled bulb and capillary.

**Electrical connection:** Silicone insulated wires H05S-K, 2.5mm<sup>2</sup>, T180°C, 450V, standard length 200mm. Wire ends with crimped terminals. Other lengths on request.

**Ground terminals:** One M4 grounding terminals with saddle is located on the wire exit side.

**Special items:** The lateral wire exit face has two M3 threads allowing 4mm<sup>2</sup> or 6mm<sup>2</sup> JPCI ATEX EX-e terminal blocks to

be mounted, two more M3 threads for direct mounting of 15mm or 35mm Din rails, and one M4 thread allowing an additional earth terminal block.

**Mounting:** Rear side, on symmetrical 35mm DIN rail

**Contacts:** SPDT, snap action contact. Electrical life 100,000 cycles.

**Electrical rating:** Suitable for power control, remote control of relay coils or PLCs circuits.

Voltage	Maximum rating (A) between:	
	Common (white) and normally closed (black)	Common (white) and normally open (red)
400V AC	16 (4)	10(2)
250V AC	25 (4)	15(2)
125V AC	25 (4)	15(2)

These devices use silver contacts or silver alloy contacts. Due to the possible oxidation of the contacts in time, we do not recommend the use of AC or DC low-voltage circuits (24V or less) if the switched intensity is less than 100mA, or the switched power less than 800mW. Contact us for those applications that require gold-plated contacts. The electrical ratings given are normalized resistive circuit values.

**Options:**

- Capillary sleeved with 6mm diameter stainless steel flexible tube
- Capillary with fitting for 6mm cable gland gasket, with or without capillary sleeving in stainless steel

**Mechanical life:** > 500.000 cycles

**Classification:**

Gas: Ex II 2G Ex db IIC T5/T6 Gb

Dust: Ex II 2D Ex tb IIIC T95°C/T80°C Db

## Main references with 200mm wire length (L1)\*\* and capillary output type 4





References with screw driver with arrow adjustment shaft	References with 10mm adjustment shaft	Temperature range	Capillary length (L2, mm)	Bulb diameter (D, mm)	Bulb length (L3, mm)	Differential (°C)	Max temperature on bulb
KABC-35035L12L	KABA-35035L12L	-35~35°C (-31~95°F)	1500	6	100	3.5±1	60°C (140°F)
KABC-10040L22L	KABA-10040L22L	-10~40°C (-14~104°F)	1500	6	130	2.5±1	70°C (158°F)
KABC-20050L32L	KABA-20050L32L	-20~50°C (-4~122°F)*	1500	6	90	3.5±1	80°C (176°F)
KABC004040L42L	KABA004040L42L	4~40°C (39.2~104°F)	1500	6	140	2±1	70°C (158°F)
KABC004040L52L	KABA004040L52L	4~40°C (39.2~104°F)	1500	8	80	2±1	70°C (158°F)
KABC000060L62L	KABA000060L62L	0~60°C (32~140°F)	1500	6	115	3±1	90°C (194°F)
KABC030090L72L	KABA030090L72L	30~90°C (86~194°F)	1500	6	110	3±1	120°C (248°F)
KABC000100L82L	KABA000100L82L	0~100°C (32~212°F)	1500	6	80	5±1.5	130°C (266°F)
KABC030110L92L	KABA030110L92L	30~110°C (86~230°F)	1500	6	85	4±1.5	140°C (284°F)
KABC000200LA2L	KABA000200LA2L	0~200°C (32~392°F)	1500	4	100	10±3	230°C (446°F)
KABC050200LB2L	KABA050200LB2L	50~200°C (122~392°F)	1500	4	120	7.5±2.5	230°C (446°F)
KABC000300LC2L	KABA000300LC2L	0~300°C (32~570°F)	1500	4	70	15±5	330°C (626°F)
KABC050300LD2L	KABA050300LD2L	50~300°C (122~572°F)	1500	4	80	12±4	330°C (626°F)
KABC050400LE2L	KABA050400LE2L	50~400°C (122~752°F)	1500	4	50	18±6	430°C (806°F)
KABC060500LF2L	KABA060500LF2L	60~500°C (140~932°F)	1500	4	120	22±8	530°C (986°F)

\* The filling liquid of these thermostatic assemblies has a freezing temperature of about -50° C (-58°F). However it is important to protect the bulb and /or the capillary against the risk of freezing if a temperature below -35°C (-31°F) can be reached in operation. Acceptable storage temperature: -50°C(-58°F).

\*\* For a longer wire, replace the 13th character (2) by 3 for 30cm, 4 for 40cm, 5 for 50cm a.s.o. For a type 1 capillary outlet: Replace the 11th character (L) with G; For a type 2 capillary outlet: Replace the 11th character (L) with C; For a type 3 capillary outlet: Replace the 11th character (L) with P. For a type 5 capillary outlet: replace the 11th character (L) with T.



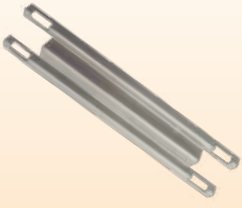
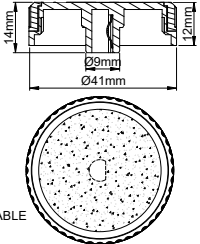
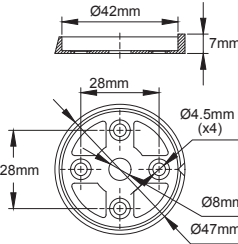
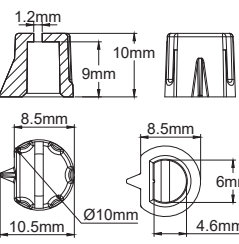
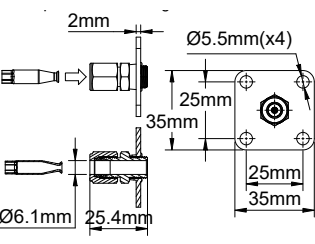
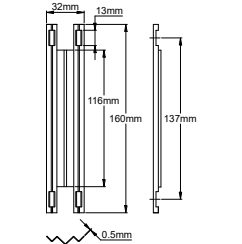
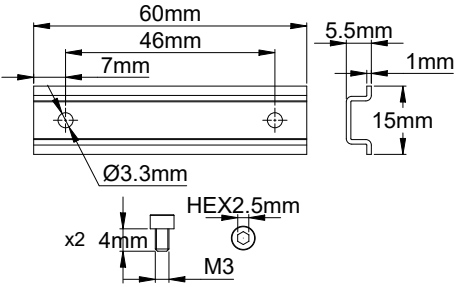
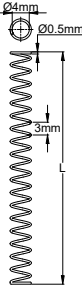
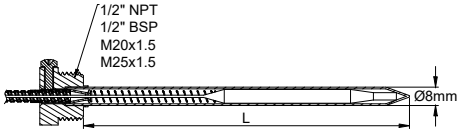

## Accessories (to be ordered separately)

Dia 40mm printed knob*	Bezel for 40mm knob*	Miniature arrow knob*	Pipe liner crossing flange	Bulb fixing profile on pipes
				
				
This knob is printed according to the temperature range of the thermostat. Available in °C or °F. It is used when the thermostat is mounted from the front, with the adjustment shaft passing through the mounting board.	Allows the positioning of the temperature mark on the knob.	To be mounted on the thermostat when it is fixed from the rear in an enclosure. Its size is greater than the arrow used with screwdriver adjustment.	This flange makes it possible to pass through the protective metal sheath located around the thermal insulation of the pipes, without risk of breaking the capillary. It is tightened by a bicone on the 6mm dia. end of the stainless-steel sheathing of the capillary	This profile makes it possible to securely fix with two clamps a thermostat bulb in contact with the wall of a pipe
<b>66MZ</b>	<b>66EN1</b>	<b>66MQ</b>	<b>66KAMB35356</b>	<b>6YTPF160032</b>
				
This accessory allows to directly mount commercial ATEX terminal blocks designed for 15mmx5.5mm rail (according to IEC60715) on the body of the KA thermostat.	This spring is mounted by screwing onto the capillary between the thermostat bulb and the stainless-steel protective sheath capillary outlets of models 1 or 4, and pushes the bulb into the bottom of the thermowell	Intended for mounting the thermostat bulb for controlling the temperature of liquid tanks		
<b>66KA1560</b>	<b>66KARE570</b>	References vary depending of thread and length. Ask us		

\* Many other knobs and bezels are described in our catalogue N°1

## Examples of special customer and sub-assemblies (requesting additional EX approval)

		
KA with special mounting board for integration inside customer enclosure, with ATEX connection blocks supplied by customer	KA for integration in any approved enclosure with 35mm DIN rail, with built-in ATEX 4mm² JPCI connection blocks	KA for integration into any approved enclosure with 35mm DIN rail, with side-mounted auxiliary 15mm DIN rail fitted with 4mm² miniature connection blocks

Update 2025/07/22





## Types of capillary outputs

- 1: Capillary protected by a flexible stainless steel metal sheath over its entire length, right out of the thermostat body. The 6mm dia. end of the stainless-steel protective sheath is rounded to avoid shearing of the capillary, and the 6mm diameter allows the mounting of accessories such as flange or thermowell (Patented). **This is the capillary protection recommended for thermostats with cable connection.**
- 2: Bare 1mm capillary without any protection.
- 3: Capillary comprising a 6mm diameter brazed fitting allowing an EX "e" box outlet via a cable gland with a 6mm passage. The part of the capillary located inside the EX "e" box is protected against the risks of electrical contact by a PTFE sheath, and the external part is bare.
- 4: Capillary comprising a 6mm diameter brazed fitting allowing an EX "e" box outlet via a cable gland with a 6mm passage. The part of the capillary located inside the EX "e" housing is protected against the risks of electrical contact by a PTFE sheath, and the external part by a flexible metal sheath in stainless steel. The 6mm dia. end of the stainless- steel protective sheath is rounded to avoid shearing of the capillary, and the 6mm diameter allows the mounting of accessories such as flange or thermowell (Patented). **This is the capillary protection recommended for thermostats with EX "e" box.**
- 5: Capillary comprising a 6mm diameter brazed fitting allowing an EX "e" box outlet via a cable gland with a 6mm passage. The part of the capillary located inside the EX "e" housing is protected against the risks of electrical contact by a PTFE sheath, and the external part by a flexible metal sheath in stainless steel. The end of the stainless-steel protective sheath is connected with the bulb to avoid exposure of the capillary. **This is the capillary protection providing the strongest mechanical strenght.**

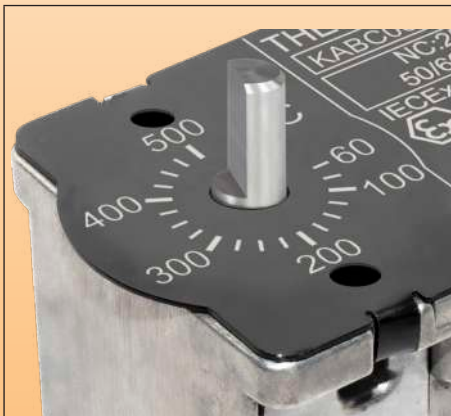

A: Shaft dia. 6mm, length 10mm, for use with printed knobs and bezels, or small plastic arrow knob (available as accessories below);



C: Screw driver type, with arrow and printed aluminum dial, for use in PPS Ex-e enclosure of JPCI or other suppliers for heat tracing;



F: Fixed and sealed temperature adjustment

## General rules for installation:

**Important note:** These thermostats are intended to monitor or control temperatures in gas or dust hazardous areas. **They can be installed in a variety of enclosures, and they can be explosion-proof enclosures, increased safety models, flameproof models, etc., or non explosion-proof enclosures, as long as they comply with the requirements of IP54 and above, and do not damage the integrity of "db" and "tb" based on the requirements of IEC 60079-0. However, we recommend that the electrical connection at the end of the cable be made in an EX "e" box.**

**For gas hazardous areas,** this equipment is approved as "Ex db" and is suitable for use in zone 1 and zone 2, gas group IIC (Hydrogen/Acetylene, the highest protection group), with a temperature classification T5/ T6;

**For dust hazardous areas,** this equipment is approved as "Ex tb", suitable for use in zone 21 and zone 22, the dust group is IIIC (electric conductive dust, the highest protection group).

The applicable ambient temperature of the equipment is:

NC: 16(4)A NO: 10(2)A, 125/250/400 VAC; 50/60 Hz; -60°C to +50°C (T6/T80°C)

NC: 16(4)A NO: 10(2)A, 125/250/400 VAC; 50/60 Hz; -60°C to +80°C (T5/T95°C)

NC: 25(4)A NO: 15(2)A, 125/250 VAC; 50/60 Hz; -60°C to +50°C (T5/T95°C)

The outlet of the capillary from this box must be carried out by a cable gland with a gasket adapted to the 6mm diameter of the capillary connection fitting and providing the degree of protection required by the standard.

The models with screw driver adjustment and front mounting allow incorporation inside most existing junction boxes having inside a free height of 60mm minimum.

With an adjustment per 10mm shaft and printed knob, this minimum height is about 70mm. We recommend checking this height by requesting plans for the devices with the knob of your choice.

**Approvals:** These thermostats are certified: ATEX: TÜV 22 ATEX 8892 X; IECEx: IECEx TUR 22. 0057 X.

CCC: 2025012304765427

**Housing:** Aluminum, 86 × 40 × 56mm (Dimensions without shaft and knob)

**Bulb and capillary:** Stainless steel. Standard capillary length 1500mm. (Other lengths available with M.O.Q) Capillary minimum bending radius 5mm.



**Temperature sensing element:** Oil or liquid metalloids filled bulb and capillary.

**Electrical connection:** Silicone insulated wire H05S-K, 2.5mm<sup>2</sup>, T180°C, 450V, standard length 1000mm. Wire ends with crimped terminals. Other lengths on request.

**Ground terminals:** One M4 grounding terminals with saddle is located on the cable exit side.

**Mounting:** Front bracket with 2 × M4 threads, 28mm distance, or backside by two M4 screws with 60mm distance

**Contacts:** SPDT, snap action contact. Electrical life 100,000 cycles.

**Electrical rating:** Suitable for power control, remote control of relay coils or PLCs circuits.

Voltage	Maximum rating (A) between:	
	Common (white) and normally closed (black)	Common (white) and normally open (red)
400V AC	16 (4)	10(2)
250V AC	25 (4)	15(2)
125V AC	25 (4)	15(2)

These devices use silver contacts or silver alloy contacts. Due to the possible oxidation of the contacts in time, we do not recommend the use of AC or DC low-voltage circuits (24V or less) if the switched intensity is less than 100mA, or the switched power less than 800mW. Contact us for those applications that require gold-plated contacts. The electrical ratings given are normalized resistive circuit values.

**Options:**

- Capillary sleeved with 6mm diameter stainless steel flexible tube
- Capillary with fitting for 6mm cable gland gasket, with or without capillary sleeving in stainless steel

**Mechanical life:** > 500,000 cycles

**Classification:**

Gas: II 2G Ex db IIC T5/T6 Gb

Dust: II 2D Ex tb IIIC T95°C/T80°C Db

## Main references with 1000mm cable length (L1)\*\*





References with screw driver with arrow adjustment shaft	References with 10mm adjustment shaft	Temperature range	Capillary length (L2, mm)	Bulb diameter (D, mm)	Bulb length (L3, mm)	Differential (°C)	Max temperature on bulb
KABC-35035L1A3	KABA-35035L1A3	-35~35°C (-31~95°F)	1500	6	100	3.5±1	60°C (140°F)
KABC-10040L2A3	KABA-10040L2A3	-10~40°C (-14~104°F)	1500	6	130	2.5±1	70°C (158°F)
KABC-20050L3A3	KABA-20050L3A3	-20~50°C (-4~122°F) *	1500	6	90	3.5±1	80°C (176°F)
KABC004040L4A3	KABA004040L4A3	4~40°C (39.2~104°F)	1500	6	140	2±1	70°C (158°F)
KABC004040L5A3	KABA004040L5A3	4~40°C (39.2~104°F)	1500	8	80	2±1	70°C (158°F)
KABC000060L6A3	KABA000060L6A3	0~60°C (32~140°F)	1500	6	115	3±1	90°C (194°F)
KABC030090L7A3	KABA030090L7A3	30~90°C (86~194°F)	1500	6	110	3±1	120°C (248°F)
KABC000100L8A3	KABA000100L8A3	0~100°C (32~212°F)	1500	6	80	5±1.5	130°C (266°F)
KABC030110L9A3	KABA030110L9A3	30~110°C (86~ 230°F)	1500	4	120	7.5±2.5	230°C (446°F)
KABC000200LAA3	KABA000200LAA3	0~200°C (32~392°F)	1500	4	100	10±3	230°C (446°F)
KABC050200LBA3	KABA050200LBA3	50~200°C (122~392°F)	1500	4	120	7.5±2.5	230°C (446°F)
KABC000300LCA3	KABA000300LCA3	0~300°C (32~570°F)	1500	4	70	15±5	330°C (626°F)
KABC050300LDA3	KABA050300LDA3	50~300°C (122~572°F)	1500	4	80	12±4	330°C (626°F)
KABC050400LEA3	KABA050400LEA3	50~400°C (122~752°F)	1500	4	50	18±6	430°C (806°F)
KABC060500LFA3	KABA060500LFA3	60~500°C (140~932°F)	1500	4	120	20±6°C	550°C (1000°F)

\* The filling liquid of these thermostatic assemblies has a freezing temperature of about -50°C (-58°F). However it is important to protect the bulb and /or the capillary against the risk of freezing if a temperature below -35°C (-31°F) can be reached in operation. Acceptable storage temperature: -50°C(-58°F).

\*\* For a longer cable, replace the 13th character (A) by B for 2m, C for 3m, D for 4m a.s.o. For a type 1 capillary outlet: Replace the 11th character (L) with G; For a type 2 capillary outlet: Replace the 11th character (L) with C; For a type 3 capillary outlet: Replace the 11th character (L) with P; For a type 5 capillary outlet: replace the 11th character (L) with T.

Because of permanent improvement of our products, drawings, descriptions, features used on these data sheets are for guidance only and can be modified without prior advice

## Accessories (to be ordered separately)

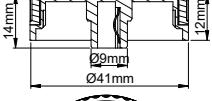
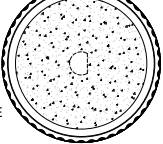
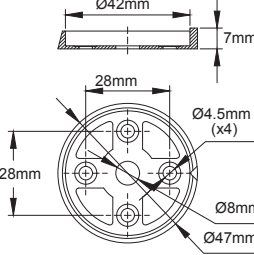
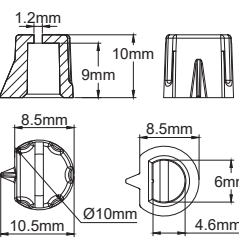
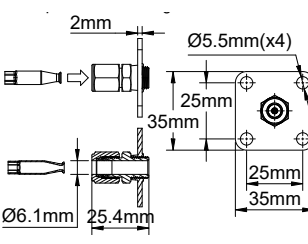
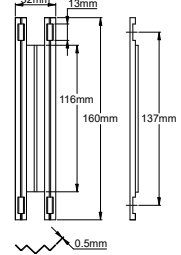
Dia 40mm printed knob*	Bezel for 40mm knob*	Miniature arrow knob*	Pipe liner crossing flange	Bulb fixing profile on pipes
				
 				
<p>This knob is printed according to the temperature range of the thermostat. Available in °C or °F. It is used when the thermostat is mounted from the front, with the adjustment shaft passing through the mounting board.</p>	<p>Allows the positioning of the temperature mark on the knob.</p>	<p>To be mounted on the thermostat when it is fixed from the rear in an enclosure. Its size is greater than the arrow used with screwdriver adjustment.</p>	<p>This flange makes it possible to pass through the protective metal sheath located around the thermal insulation of the pipes, without risk of breaking the capillary. It is tightened by a bicone on the 6mm dia. end of the stainless-steel sheathing of the capillary</p>	<p>This profile makes it possible to securely fix with two clamps a thermostat bulb in contact with the wall of a pipe</p>
<p><b>66MZ</b></p>	<p><b>66EN1</b></p>	<p><b>66MQ</b></p>	<p><b>66KAMB35356</b></p>	<p><b>6YTPF160032</b></p>

\* Many other knobs and bezels are described in our catalogue N°1

This cable output cannot be used with cable length more than 2m for ratings between 16A and 25A.

Because of permanent improvement of our products, drawings, descriptions, features used on these data sheets are for guidance only and can be modified without prior advice

Because of permanent improvement of our products, drawings, descriptions, features used on these data sheets are for guidance only and can be modified without prior advice

## Temperature control, 35mm DIN rail mounting, cable connection

Electrical connection	Set point adjustment	Mounting	Action	Contact Rating	T° ranges min and max adjustment limits	Types
Cable	- 10mm shaft - Screwdriver on dial - Fixed setting	Rear 35mm DIN Rail	Control	SPDT 16(4)A, 400VAC 25(4)A, 250VAC	-50 to + 50°C	<b>KAB-4</b>

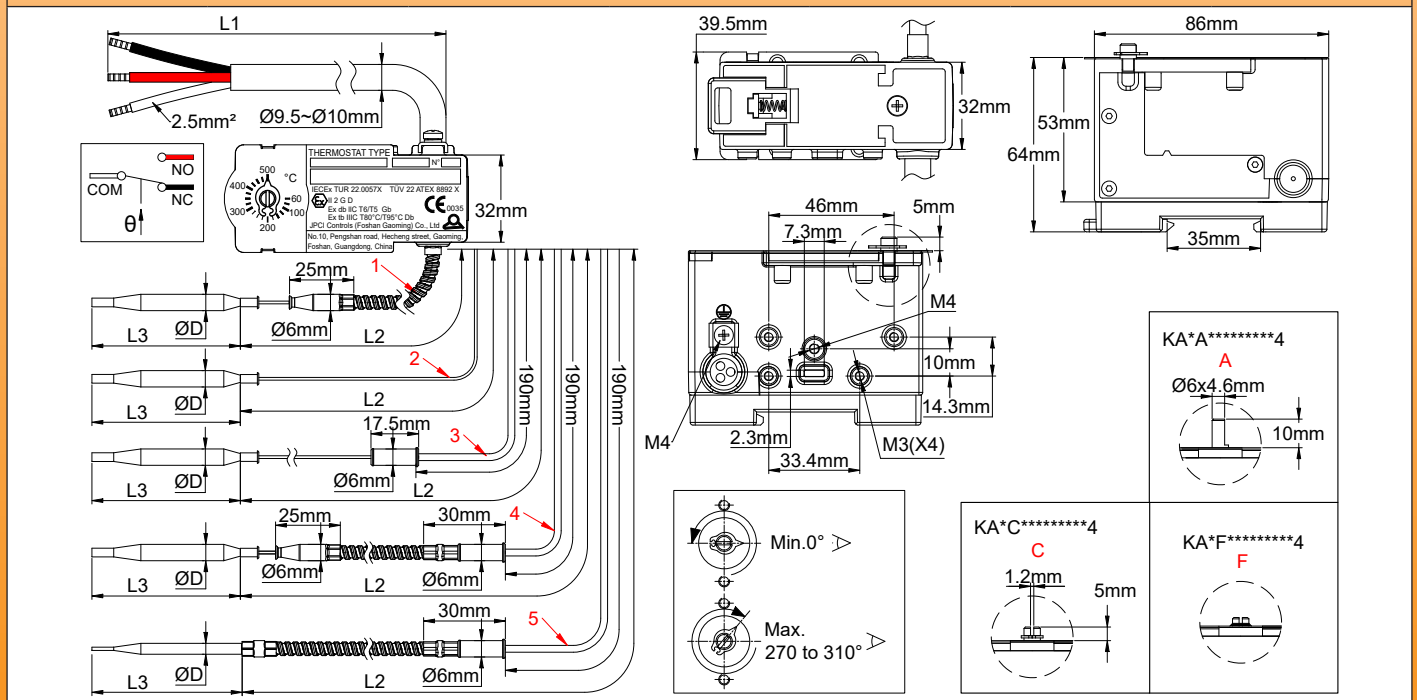
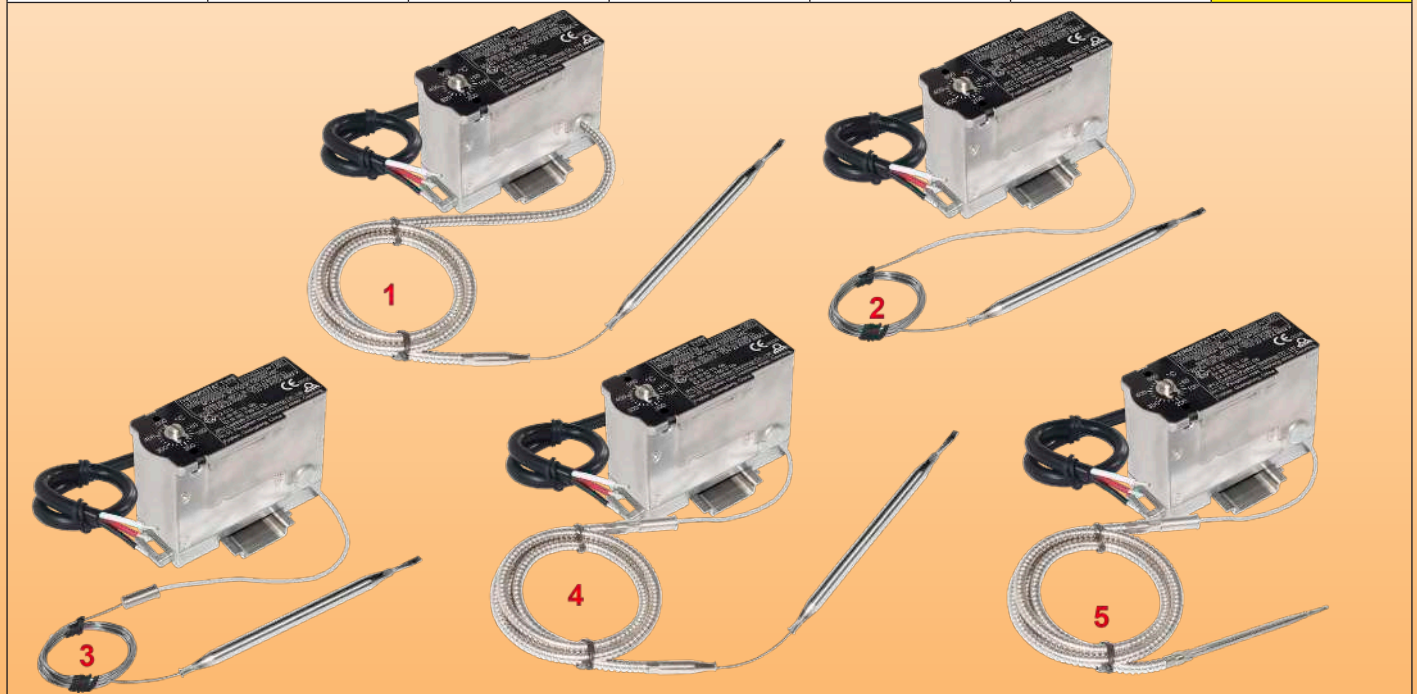

## Types of capillary outputs

- 1: Capillary protected by a flexible stainless steel metal sheath over its entire length, right out of the thermostat body. The 6mm dia. end of the stainless-steel protective sheath is rounded to avoid shearing of the capillary, and the 6mm diameter allows the mounting of accessories such as flange or thermowell (Patented). **This is the capillary protection recommended for thermostats with cable connection.**
- 2: Bare 1mm capillary without any protection.
- 3: Capillary comprising a 6mm diameter brazed fitting allowing an EX “e” box outlet via a cable gland with a 6mm passage. The part of the capillary located inside the EX “e” box is protected against the risks of electrical contact by a PTFE sheath, and the external part is bare.
- 4: Capillary comprising a 6mm diameter brazed fitting allowing an EX “e” box outlet via a cable gland with a 6mm passage. The part of the capillary located inside the EX “e” housing is protected against the risks of electrical contact by a PTFE sheath, and the external part by a flexible metal sheath in stainless steel. The 6mm dia. end of the stainless- steel protective sheath is rounded to avoid shearing of the capillary, and the 6mm diameter allows the mounting of accessories such as flange or thermowell (Patented). **This is the capillary protection recommended for thermostats with EX “e” box.**
- 5: Capillary comprising a 6mm diameter brazed fitting allowing an EX “e” box outlet via a cable gland with a 6mm passage. The part of the capillary located inside the EX “e” housing is protected against the risks of electrical contact by a PTFE sheath, and the external part by a flexible metal sheath in stainless steel. The end of the stainless-steel protective sheath is connected with the bulb to avoid exposure of the capillary. **This is the capillary protection providing the strongest mechanical strenght.**

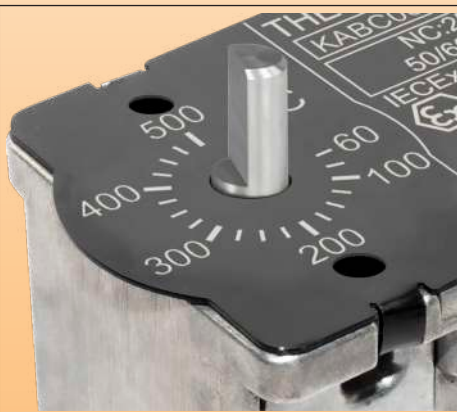

A: Shaft dia. 6mm, length 10mm, for use with printed knobs and bezels, or small plastic arrow knob (available as accessories below);



C: Screw driver type, with arrow and printed aluminum dial, for use in PPS Ex-e enclosure of JPCI or other suppliers for heat tracing;



F: Fixed and sealed temperature adjustment

## General rules for installation:

**Important note:** These thermostats are intended to monitor or control temperatures in gas or dust hazardous areas.

**They can be installed in a variety of enclosures, and they can be explosion-proof enclosures, increased safety models, flameproof models, etc., or non explosion-proof enclosures, as long as they comply with the requirements of IP54 and above, and do not damage the integrity of “db” and “tb” based on the requirements of IEC 60079-0. However, we recommend that the electrical connection at the end of the cable be made in an EX “e” box.**

**For gas hazardous areas,** this equipment is approved as “Ex db” and is suitable for use in zone 1 and zone 2, gas group IIC (Hydrogen/Acetylene, the highest protection group), with a temperature classification T5/ T6;

**For dust hazardous areas,** this equipment is approved as “Ex tb”, suitable for use in zone 21 and zone 22, the dust group is IIIC (electric conductive dust, the highest protection group).

The applicable ambient temperature of the equipment is:

NC: 16(4)A NO: 10(2)A, 125/250/400 VAC; 50/60 Hz; -60°C to +50°C (T6/T80°C)

NC: 16(4)A NO: 10(2)A, 125/250/400 VAC; 50/60 Hz; -60°C to +80°C (T5/T95°C)

NC: 25(4)A NO: 15(2)A, 125/250 VAC; 50/60 Hz; -60°C to +50°C (T5/T95°C)

The outlet of the capillary from this box must be carried out by a cable gland with a gasket adapted to the 6mm diameter of the capillary connection fitting and providing the degree of protection required by the standard.

The models with screw driver adjustment and front mounting allow incorporation inside most existing junction boxes in having inside a free height of 65mm minimum above the DIN rail.

With an adjustment per 10mm shaft and printed knob, this minimum height is about 75mm. We recommend checking this height by requesting plans for the devices with the knob of your choice.

**Approvals:** These thermostats are certified:

ATEX: TÜV 22 ATEX 8892 X; IECEx: IECEx TUR 22. 0057 X. CCC: 2025012304765427

**Housing:** Aluminum, 86 × 40 × 64mm (Dimensions without shaft and knob)

**Bulb and capillary:** Stainless steel. Standard capillary length 1500mm. (Other lengths available with M.O.Q) Capillary minimum bending radius 5mm.

**Temperature sensing element:** Oil or liquid metalloids filled bulb and capillary.



**Electrical connection:** Silicone insulated wires H05S-K, 2.5mm<sup>2</sup>, T180°C, 450V, standard length 200mm. Wire ends with crimped terminals. Other lengths on request.

**Ground terminals:** One M4 grounding terminals with saddle is located on the wire exit side.

**Mounting:** Rear side, on symmetrical 35mm DIN rail

**Contacts:** SPDT, snap action contact. Electrical life 100,000 cycles.

**Electrical rating:** Suitable for power control, remote control of relay coils or PLCs circuits.

Voltage	Maximum rating (A) between:	
	Common (white) and normally closed (black)	Common (white) and normally open (red)
400V AC	16 (4)	10(2)
250V AC	25 (4)	15(2)
125V AC	25 (4)	15(2)

These devices use silver contacts or silver alloy contacts. Due to the possible oxidation of the contacts in time, we do not recommend the use of AC or DC low-voltage circuits (24V or less) if the switched intensity is less than 100mA, or the switched power less than 800mW. Contact us for those applications that require gold-plated contacts. The electrical ratings given are normalized resistive circuit values.

**Options:**

- Capillary sleeved with 6mm diameter stainless steel flexible tube
- Capillary with fitting for 6mm cable gland gasket, with or without capillary sleeving in stainless steel

Mechanical life: > 500,000 cycles

**Classification:**

Gas: II 2G Ex db IIC T5/T6 Gb

Dust: II 2D Ex tb IIIC T95°C/T80°C Db

## Main references with 1000mm cable length (L1) and capillary output type 4\*\*

References with screw driver with arrow adjustment shaft	References with 10mm adjustment shaft	Temperature range	Capillary length (L2, mm)	Bulb diameter (D, mm)	Bulb length (L3, mm)	Differential (°C)	Max temperature on bulb
KABC-35035L1A4	KABA-35035L1A4	-35~35°C (-31~95°F)	1500	6	100	3.5±1	60°C (140°F)
KABC-10040L2A4	KABA-10040L2A4	-10~40°C (-14~104°F)	1500	6	130	2.5±1	70°C (158°F)
KABC-20050L3A4	KABA-20050L3A4	-20~50°C (-4~122°F) *	1500	6	90	3.5±1	80°C (176°F)
KABC004040L4A4	KABA004040L4A4	4~40°C (39.2~104°F)	1500	6	140	2±1	70°C (158°F)
KABC004040L5A4	KABA004040L5A4	4~40°C (39.2~104°F)	1500	8	80	2±1	70°C (158°F)
KABC000060L6A4	KABA000060L6A4	0~60°C (32~140°F)	1500	6	115	3±1	90°C (194°F)
KABC030090L7A4	KABA030090L7A4	30~90°C (86~194°F)	1500	6	110	3±1	120°C (248°F)
KABC000100L8A4	KABA000100L8A4	0~100°C (32~212°F)	1500	6	80	5±1.5	130°C (266°F)
KABC030110L9A4	KABA030110L9A4	30~110°C (86~230°F)	1500	4	120	7.5±2.5	230°C (446°F)
KABC000200LAA4	KABA000200LAA4	0~200°C (32~392°F)	1500	4	100	10±3	230°C (446°F)
KABC050200LBA4	KABA050200LBA4	50~200°C (122~392°F)	1500	4	120	7.5±2.5	230°C (446°F)
KABC000300LCA4	KABA000300LCA4	0~300°C (32~570°F)	1500	4	70	15±5	330°C (626°F)
KABC050300LDA4	KABA050300LDA4	50~300°C (122~572°F)	1500	4	80	12±4	330°C (626°F)
KABC050400LEA4	KABA050400LEA4	50~400°C (122~752°F)	1500	4	50	18±6	430°C (806°F)
KABC060500LFA4	KABA060500LFA4	60~500°C (140~932°F)	1500	4	120	20±6°C	550°C (1000°F)





\* The filling liquid of these thermostatic assemblies has a freezing temperature of about -50° C (-58°F). However it is important to protect the bulb and /or the capillary against the risk of freezing if a temperature below -35°C (-31°F) can be reached in operation. Acceptable storage temperature: -50°C(-58°F).

\*\* For a longer cable, replace the 13th character (A) by B for 2m, C for 3m, D for 4m a.s.o. For a type 1 capillary outlet: Replace the 11th character (L) with G; For a type 2 capillary outlet: Replace the 11th character (L) with C; For a type 3 capillary outlet: Replace the 11th character (L) with P; For a type 5 capillary outlet: replace the 11th character (L) with T.

Because of permanent improvement of our products, drawings, descriptions, features used on these data sheets are for guidance only and can be modified without prior advice

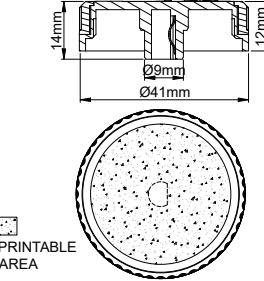
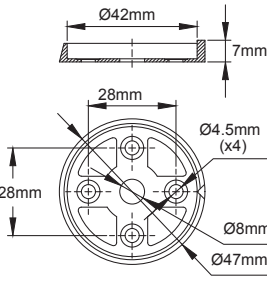
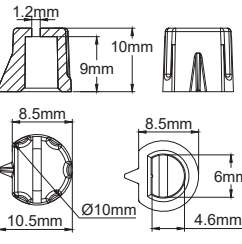
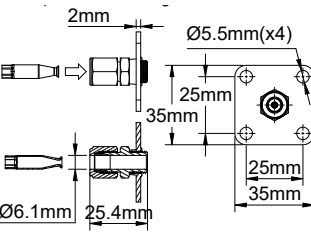
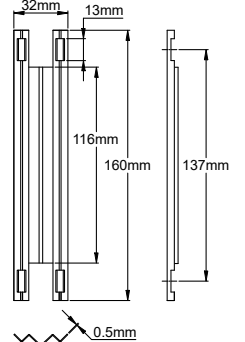

## Accessories (to be ordered separately)

Dia 40mm printed knob*	Bezel for 40mm knob*	Miniature arrow knob*	Pipe liner crossing flange	Bulb fixing profile on pipes
				
				
<p>This knob is printed according to the temperature range of the thermostat. Available in °C or °F. It is used when the thermostat is mounted from the front, with the adjustment shaft passing through the mounting board.</p>	<p>Allows the positioning of the temperature mark on the knob.</p>	<p>To be mounted on the thermostat when it is fixed from the rear in an enclosure. Its size is greater than the arrow used with screwdriver adjustment.</p>	<p>This flange makes it possible to pass through the protective metal sheath located around the thermal insulation of the pipes, without risk of breaking the capillary. It is tightened by a bicone on the 6mm dia. end of the stainless-steel sheathing of the capillary</p>	<p>This profile makes it possible to securely fix with two clamps a thermostat bulb in contact with the wall of a pipe</p>
66MZ	66EN1	66MQ	66KAMB35356	6YTYPF160032

\* Many other knobs and bezels are described in our catalogue N°1

This cable output cannot be used with cable length more than 2m for ratings between 16A and 25A.

Because of permanent improvement of our products, drawings, descriptions, features used on these data sheets are for guidance only and can be modified without prior advice



**8Z: 3 poles manual reset fail safe temperature limiters\***, not current sensing, calibration up to 130°C (266°F), 6.35 tabs or screw terminals, rating 20(3.3) A 250V, 16(2.6)A 400V, **to use when R290 highly flammable refrigerant classed A3 upon ISO 817 may be present.** This is not Ex certified product but made specially for heat pumps applications

8Z30	8Z31	8Z32	8Z33
8Z36	8Z37	8Z38	8Z39

Mounting by M10×1 front bushing, vertical terminals (standard), type 8Z30 and 8Z36

Mounting by M10×1 front bushing or mounting brackets, horizontal terminals, type 8Z31 and 8Z37

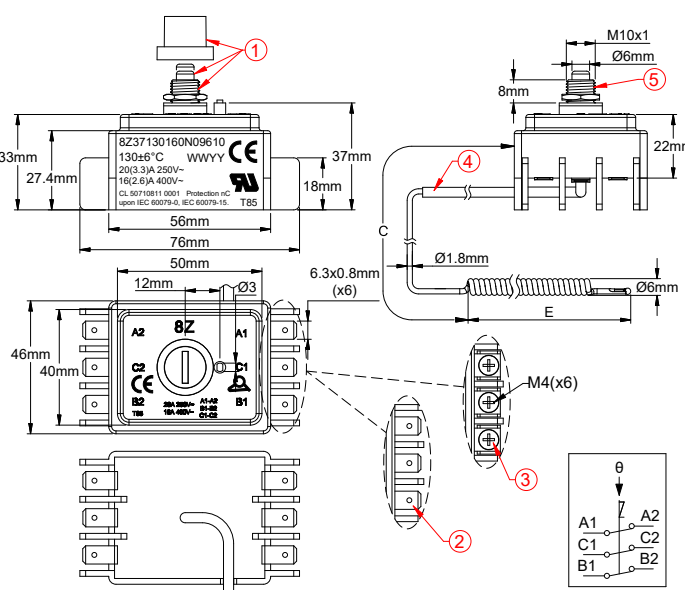
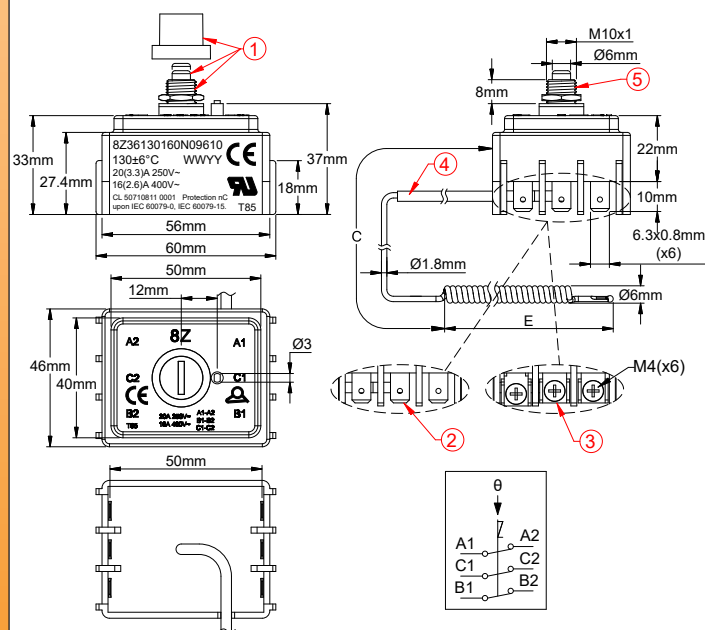

- 1: Manual reset button, M10 nut and protection cap
- 2: 6.3 × 0.8 brass terminal (option), 8Z36
- 3: M4 screw and saddle terminals (Standard), 8Z30
- 4: PVC sleeved copper capillary
- 5: M10×1 bush mounting

- 1: Manual reset button, M10 nut and protection cap
- 2: 6.3 × 0.8 brass terminal (option), 8Z37
- 3: M4 screw and saddle terminals (Standard), 8Z31
- 4: PVC sleeved copper capillary
- 5: M10×1 bush mounting

\* : 1 and 2 poles are also available.

Mounting by rear bracket, vertical terminals (not recommended), type 8Z32 and 8Z38	Mounting by rear bracket, horizontal terminals, type 8Z33 and 8Z39
<p>1: Manual reset button                  2: 6.3 × 0.8 brass terminal (option), 8Z38                  3: M4 screw and saddle terminals (Standard), 8Z32                  4: PVC sleeved copper capillary                  5: Wall mounting rear bracket</p>	<p>1: Manual reset button                  2: 6.3 × 0.8 brass terminal (option), 8Z39                  3: M4 screw and saddle terminals (Standard), 8Z33                  4: PVC sleeved copper capillary                  5: Wall mounting rear bracket</p>

## Main applications

### General rules for installation:

**Important note:** Fully compliant for **heat pumps** and **water heater heat pumps** using **R290** refrigerant according to **EN60335-2-40** (Particular requirements for electrical heat pumps) – Arcs and sparks protection chapter.

### General description:

This Thermal Cut Out was designed as a sealed device as per IEC 60079-15:2017.

The Thermal Cut Out met the requirements of IEC 60079-15: 2017 clause 9.

The Thermal Cut Out was examined and tested according to clause 26.5.1.2 of IEC 60079-0: 2017 and clause 11.2 of IEC 60079-15: 2017.

The Thermal Cut Out passed the test items, complies with the relevant clauses of IEC 60079-15: 2017 cited by IEC 60335-2-40: 2024 and UL 60335-2-40: 2022, applicable to appliance with A3 refrigerants.

### Certification:

- **UL:** UL 60730-1, UL 60730-2-9, CAN/CSA E60730-1:15, UL/CSA E60730-2-9 (6,000 cycles)
- **CE:** LVD certified by TÜV, EN60730-1, EN60730-2-9 (6,000 cycles)
- **Explosive atmosphere** by TÜV according to standards and specific chapters above.
- **Registration No.:** CL 50710811 0001

## Technical features

**Housing dimensions:** see drawings

**Capillary:** Copper, capillary length 500 or 900 mm. Black PVC sleeve on capillary. Capillary minimum bending radius 5 mm. For technical reasons, we do not recommend to use capillary length longer than 900 mm. We don't recommend 500mm long capillary for calibration temperature above 90°C (194°F)

Special lengths on request.

**Bulb:** Copper, corkscrew type for temperatures from 70 to 130°C (158 to 266°F).

Straight uncoiled capillary available on request

**Temperature sensing element:** Liquid-filled thermostatic assembly whose boiling causes tripping of the contact. Therefore, unlike liquid filled systems, these thermostats are sensitive to atmospheric pressure, and their reaction time is faster.

**Terminals:** Six 6.35 × 0.8 quick connect terminals, or 6 M4 input screw terminals with saddle. (Other terminals combinations are possible). Terminals can be horizontal or vertical

**Adjustment:** Fixed setting

**Mounting:** Front bushing, with M10 × 1 thread

# Bulb and capillary thermostats for incorporation



Because of permanent improvement of our products, drawings, descriptions, features used on these data sheets are for guidance only and can be modified without prior advice

**Manual reset:** Fail safe action, front access button

**Contacts:** 3 poles single throw 20(3.3)A 250V, 16(2.6)A 400V snap action contact. Single pole and double pole available with same dimensions.

**Max ambient temperature on head:** 85°C (185°F). Must not be higher than calibration temperature -10°C (-18°F).

**Acceptable degree of pollution for use in 250V:** 3

**Acceptable degree of pollution for use in 400V:** 2

## Main references with vertical terminals and M10×1 bush mounting, without rear bracket\*

Model 8Z30		Calibration temperature (°C/°F)	Minimum resettable temperature (°C/°F)	Capillary length (C, mm)	Bulb diameter (D, mm)	Bulb length (E, mm)	Max temperature on bulb (°C/°F)
References with six 6.35 terminals	References with six M4 screw terminals						
8Z36070100N096N0	8Z30070100N096N0	70±5°C/158±9°F	30°C/86°F	900	6	50	100°C/212°F
8Z36070100N056N0	8Z30070100N056N0			500			
8Z36080110N096N0	8Z30080110N096N0	80±5°C/176±9°F	40°C/104°F	900	6	50	110°C/230°F
8Z36080110N056N0	8Z30080110N056N0			500			
8Z36090120N096N0	8Z30090120N096N0	90±5°C/194±9°F	50°C/122°F	900	6	50	120°C/248°F
8Z36090120N056N0	8Z30090120N056N0			500			
8Z36110140N096N0	8Z30110140N096N0	110±5°C/230±9°F	70°C/158°F	900	6	50	140°C/284°F
8Z36110140N056N0	8Z30110140N056N0			500			
8Z36120150N096N0	8Z30120150N096N0	120±6°C/248±11°F	80°C/176°F	900	6	60	150°C/302°F
8Z36120150N056N0	8Z30120150N056N0			500			
8Z36130160N096N0	8Z30130160N096N0	130±6°C/266±11°F	90°C/194°F	900	6	60	160°C/320°F
8Z36130160N056N0	8Z30130160N056N0			500			

\* For others configurations, replace 8Z30 by the type provided on drawings on top of this page and also 61 by 60 for models with rear side bracket mounting.

\*\* Maximum manual reset set point is 130°C±6°C. Ask for specific data sheets

**81: 3 poles manual reset fail safe temperature limiters, double break contacts, calibration up to 130°C(266°F), 6.35 tabs, rating 25 A (4 A) 250 V, 20 A (3.3 A) 400 V, rear mounting, to use when R290 highly flammable refrigerant classed A3 upon ISO 817 may be present. This is not Ex certified product but made specially for heat pumps applications**

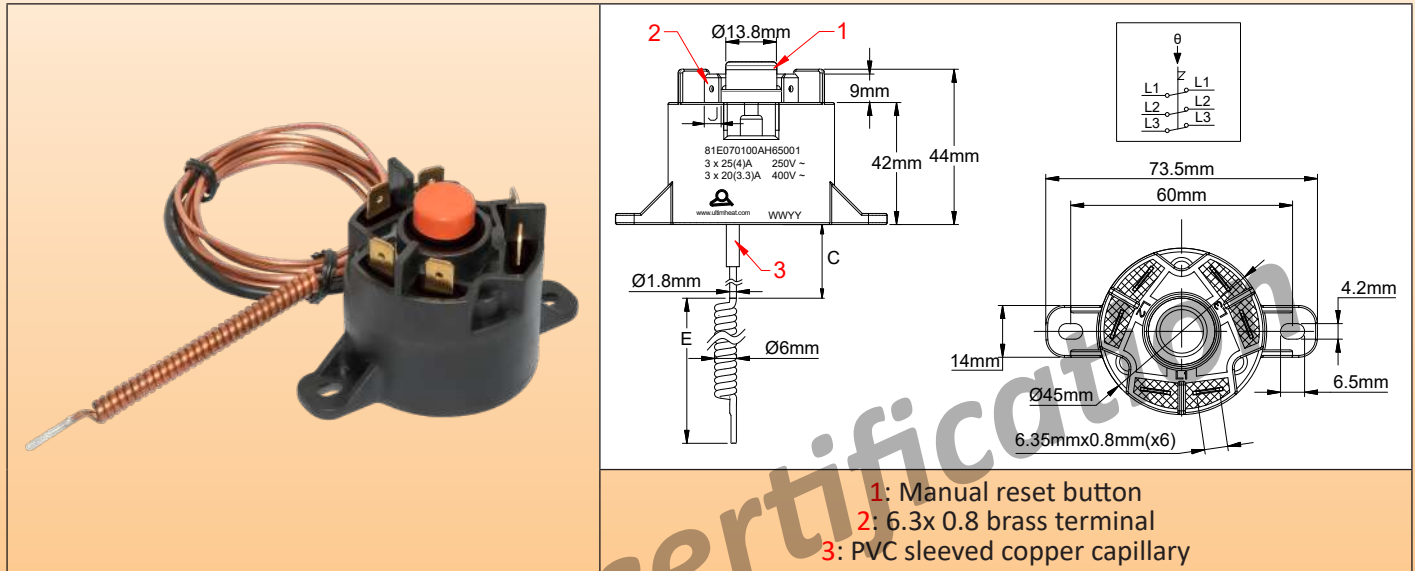

## Main applications

**Important Note:** Fully compliant with the requirements for heat pumps and thermodynamic water heaters using R290 refrigerant, in accordance with EN 60335-2-40 (Special requirements for electric heat pumps) – Chapter on protection against arc flash and sparks.

### General Description:

This thermal cut-out has been designed as a sealed device in accordance with IEC 60079-15:2017.

The thermal cut-out meets the requirements of Clause 9 of IEC 60079-15:2017.

The thermal cut-out has been examined and tested in accordance with Clause 26.5.1.2 of IEC 60079-0:2017 and Clause 11.2 of IEC 60079-15:2017.

The thermal cut-out has passed testing and complies with the relevant sections of IEC 60079-15:2017, as cited by IEC 60335-2-40:2024 and UL 60335-2-40:2022, applicable to equipment using Class A3 refrigerants.

### Certification:

- **UL:** UL 60730-1, UL 60730-2-9, CAN/CSA E60730-1:15, UL/CSA E60730-2-9 (6000 cycles)
- **CE:** LVD certified by TÜV, EN60730-1, EN60730-2-9 (6.000 cycles)
- **Explosive atmosphere:** certified by TÜV according to standards and specific chapters above.

**Certification test number:** CL \*\*\*\*\*.

## Technical features

**Housing dimensions:** see drawings

**Capillary:** Copper, capillary length 500 or 900 mm. Black PVC sleeve on capillary. Capillary minimum bending radius 5 mm.

For technical reasons, we do not recommend to use capillary length longer than 900 mm. We don't recommend 500mm long capillary for calibration temperature above 90°C (194°F)

Special lengths on request.

**Bulb:** Copper, corkscrew type for temperatures from 70 to 130°C (158 to 266°F).

Straight uncoiled capillary available on request

**Temperature sensing element:** Liquid-filled thermostatic assembly whose boiling causes tripping of the contact. Therefore, unlike liquid filled systems, these thermostats are sensitive to atmospheric pressure, and their reaction time is faster.

**Terminals:** Six 6.35 x 0.8, vertical quick connect terminals, epoxy sealed

**Adjustment:** Fixed setting

**Mounting:** rear bracket for 2 screws dia. 4mm, 60mm distance

**Manual reset:** Fail safe action, by waterproof front access button

**Contacts:** 3 poles single throw, 3 x 25A 250V, 3 x 20A 400V snap action, double break contacts.

## Bulb and capillary thermostats for incorporation



Because of permanent improvement of our products, drawings, descriptions, features used on these data sheets are for guidance only and can be modified without prior advice

**Max ambient temperature on head:** 85°C (185°F). Must not be higher of 10°C (18°F) than calibration temperature

**Acceptable degree of pollution for use in 250V:** 2

**Acceptable degree of pollution for use in 400V:** 2

**Option:** the spiral capillary in the shape of a bulb of dia. 6mm can be replaced by a tubular phial, but then the thermal response time is greatly increased.

**Important safety note:** Due to the presence of electrical connections near the reset button, disconnect the power supply before accessing it.

### Main references \*

References	Calibration temperature (°C/°F)	Minimum resettable temperature (°C/°F)	Capillary length (C, mm)	Bulb diameter (D, mm)	Bulb length (E, mm)	Max temperature on bulb (°C/°F)
81E070100AH65001	70±5°C/158±9°F	30°C/86°F	900	6	50	100°C/212°F
81E070100AD65001			500			
81E080110AH65001	80±5°C/176±9°F	40°C/104°F	900	6	50	110°C/230°F
81E080110AD65001			500			
81E090120AH65001	90±5°C/194±9°F	50°C/122°F	900	6	50	120°C/248°F
81E090120AD65001			500			
81E110140AH65001	110±5°C/230±9°F	70°C/158°F	900	6	50	140°C/284°F
81E110140AD65001			500			
81E120150AH65001	120±6°C/248±11°F	80°C/176°F	900	6	60	150°C/302°F
81E120150AD65001			500			
81E130160AH65001	130±6°C/266±11°F	90°C/194°F	900	6	60	160°C/320°F
81E130160AD65001			500			

\* Other lengths on request



Because of permanent improvement of our products, drawings, descriptions, features used on these data sheets are for guidance only and can be modified without prior advice



# Section 6

## Connection boxes and enclosures with or without connection blocks, intended to receive KA, KY, or KZ thermostats, specially designed for heat tracing **and pipe mounting**



Because of permanent improvement of our products, drawings, descriptions, features used on these data sheets are for guidance only and can be modified without prior advice

## Section 6 Technical introduction on connection boxes for potentially explosive environments

### First part

Connection boxes for heat tracing cables, with **screw terminals**, for standard heating cables, self-regulating cables and standard power supply cables. Connections in industrial **hazardous** environments. For industrial **non-hazardous** environments **see catalogue 12**

### The unrivaled advantages of Ultimheat self-regulating or traditional heating cable connection boxes

(Compatible with power supply traditional round cables, constant power heating cables, flat self-regulating cables with polypropylene, silicone semiconductor, or fluorinated compound cores)

### 6 essential requirements on all EX-e enclosures

						
<p><b>Terminal blocks:</b> Depending on the box models, the terminal blocks have a clamping capacity of 4mm<sup>2</sup> (for 16A) or 6mm<sup>2</sup> (for 32A). They all include a system to prevent loosening due to vibrations. <u>Described by standards:</u> IEC60730-1 table 10. Also in IEC60335-1</p>	<p><b>Grounding:</b> Depending on the box models, the equipotential grounding is external and internal (Aluminium cases) or simply internal (PPS boxes). <u>Described by standards:</u> IEC60076-0:15:3, IEC60034-1, and GB3836.1:15:3</p>	<p><b>Antistatic protection:</b> Depending on the material of the boxes, the thickness of the paint is regulated (Aluminum boxes with epoxy coating), where the maximum surface resistance of the plastic material is regulated (PPS boxes). <u>Described by standards:</u> IEC60079-0: 74.4; GB3836.1:7.4; and IEC IEC 60243-1; IEC 60243-2</p>	<p><b>Cable pull-out force:</b> Power cables and heating cables must withstand a pull force depending on their perimeter, significantly greater than what is required of conventional cable glands. Most of our connection boxes have a special tightening saddle for it. <u>Described by standards:</u> IEC60079-0: Annex A; GB3836.1: Annex A</p>	<p><b>Types of lid screws:</b> Closing of the box lids must be ensured by special screws, resistant to loosening by vibration and not protruding. The threads must respect a minimum length, pitch tolerances, and be metallic. <u>Described by standards:</u> IEC 60079-0:9.2, special fasteners; GB3836.1:9.2</p>	<p><b>Impact resistance:</b> The required impact resistance of the boxes is significantly higher than the standard maximum IK10 class, and achieved with specific equipment both on the boxes and on the cable glands. <u>Described by standards:</u> IEC 60079-0:26.4.2; GB3836.1:26.4.2</p>	

And numerous other mandatory rules apply to the connections for insulation, tracking and surface distances depending of material and degree of pollution, temperature resistance, etc. As for every requirement of standards, everything is designed accordingly and carefully checked and tested in our own UL and CE recognized laboratory



# Explosion proof connection boxes



## Second part

Connection boxes for heat tracing cables, **with insulation piercing terminals**, for self-regulating cables and standard power supply cables.

Connections in industrial **hazardous** environments. For industrial **non-hazardous** environments **see catalogue 12**

### The unrivaled advantages of Ultimheat insulation piercing self-regulating heating cable connection boxes

(Compatible with self-regulating cables with polypropylene, silicone semiconductor, or fluorinated cores)

### Insulation piercing terminals 5 technical improvements

<b>1:</b> Anti-vibration blocking and resistant to thermal cycles of the screws after tightening.	<b>2:</b> Multiple chisels reducing contact resistance with electrical conductors and eliminating hot spots. <b>This design allows the 32A rating</b>	<b>3:</b> Terminal opening spring facilitating insertion and allowing possible replacement of heating cables.	<b>4:</b> Captive screws: They don't fall down during connection	<b>5:</b> Choice of housing material, <b>aluminum</b> or <b>PPS</b> depending on environmental, industrial or marine conditions

### Connection on "cold" conductors 5 technical improvements

<b>1:</b> Anti-vibration blocking of the terminal block screws, resistant to thermal cycles.	<b>2:</b> Terminals allow flexible stranded or rigid conductors from 1 to 6mm <sup>2</sup> , stripped or not.	<b>3:</b> Large insertion hole for conductors up to 6mm <sup>2</sup> , with guide ramps. No tortuous circuit to make to these conductors.	<b>4:</b> Ground terminal for conductors up to 6mm <sup>2</sup> , with anti-vibration screws tightening and protection blade	<b>5:</b> Captive screws: They don't fall down during connection

Because of permanent improvement of our products, drawings, descriptions, features used on these data sheets are for guidance only and can be modified without prior advice

## Installation

### 3 technical improvements



1: Two built-in tabs for mounting on a flat wall.



2: Two removable legs for fitting on pipes, providing a 10 mm offset from the tube. Ideal and economical for applications with low insulation thickness and pipe temperature below 100°C. Clamping on metal or PVC piping can be made by nylon tie or metal clamp (These tabs are included as standard).



3: One stainless steel bracket, for offset mounting on piping, allowing the enclosure to be locked in after the insulation and its protection have been installed. Allow an insulation thickness of 50 mm, and can be used on hot pipes. Clamping on metal or PVC piping by nylon tie or metal clamp. (Legs available as an accessory.)

## Lids

### 4 technical improvements



1: Four captive stainless-steel screws tightening on metal inserts. No screwing into the plastic, no fragile hinges.



2: Riveted identification label, anodized aluminum, laser printed, weatherproof and tamperproof.



3: Two tabs for red safety seals allow the tamperproof sealing of the lid and a second set of two tabs allow to install a chain to hold the lid



4: Graduated scale in cm, engraved, with mechanical stop at 0 cm, to ease the stripping length measurement.



## Cable glands 5 technical improvements

<p><b>1:</b> Specially designed to comply with the high tear force requested by industrial and hazardous area standards, the built-in cable glands are made of aluminium or black PPS, UV resistant. They are IP67 and IP69K, therefore they withstand immersion and high-pressure hot water washing.</p>	<p><b>2:</b> Thanks to two springs, the locking saddle for round or flat cable maintains the earth continuity of the metal braid in the event of deformation of the cable, and connection to the equipotential ground line (Patented).</p>	<p><b>3:</b> This locking saddle provides a powerful tightening of the cable which is independent of the tightening torque of the gland nut, avoiding any tearing.</p>	<p><b>4:</b> Captive saddle screws.</p>	<p><b>5:</b> A whole range of gaskets in 70 shore silicone and in 70 shore NBR makes it possible to cover all the dimensions of round or flat cables.</p>

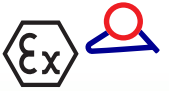
# EX « e » round connection boxes, dia 150mm, in PPS, IP66

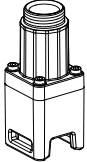
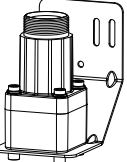

Electrical heat tracing boxes, for wall mounting or pipes mounting, intended for the incorporation of connection blocks or mechanical or electronic thermostats.

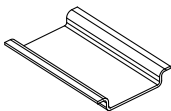
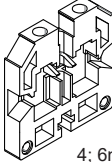
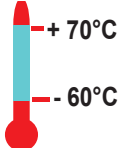
Pipe mounting leg (Y92)	Pole or wall mounting leg (Y93)	Maximum electrical rating	Mounting accessories (option)	Connection blocks in option	Min and max ambient temperature	Types
Length 125mm with multiple holes cable gland	Length 100 mm with multiple holes cable gland and pole or wall mounting stainless board	25A 400V (T5 self heating)	Rail Din 35mm (Y93) or KA thermostat direct mounting (Y92)	- When used with KA thermostat: up to 8 in 4mm <sup>2</sup> or up to 7 in 6mm <sup>2</sup>	-60 to +70°C	Y92 Y93
						

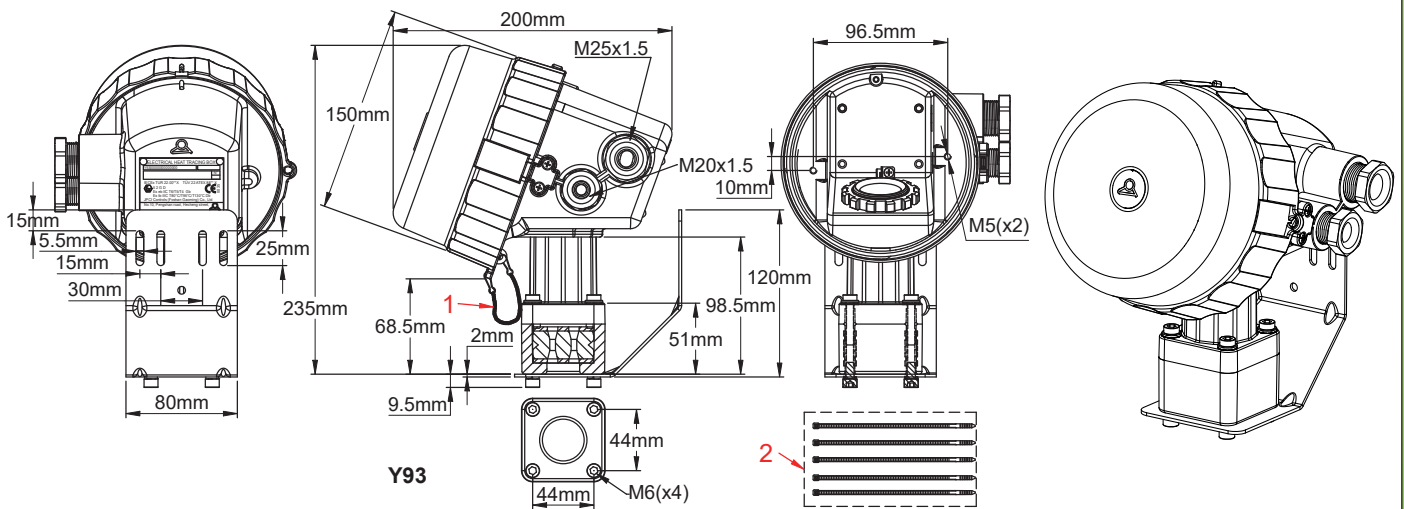
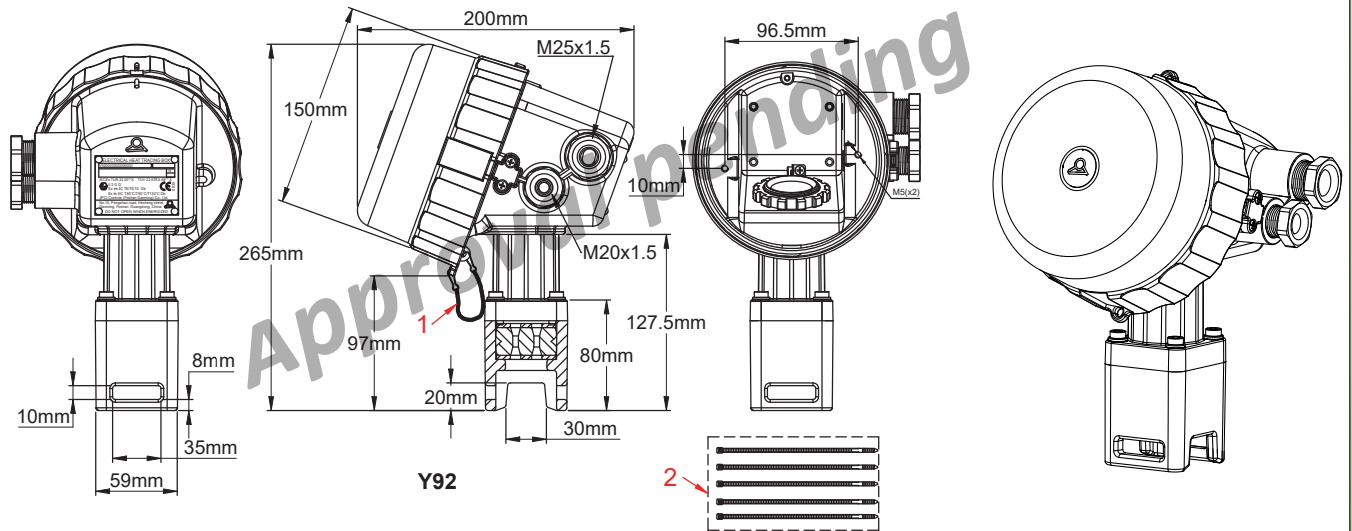

1: Lid chain; 2: Red seal

Because of permanent improvement of our products, drawings, descriptions, features used on these data sheets are for guidance only and can be modified without prior advice



## Examples of various versions

Y92, lid closed	Y92, Lid open, empty	Y93, lid closed	Y93, Lid open, empty
Y92, Lid open, with JPCI connection blocks mounting board	Y92, Lid open, with Din rail	Y93, Lid open, with JPCI connection blocks mounting board	Y93, Lid open, with Din rail

## General rules for installation:

**Important note:** These connection boxes are intended to monitor or control ambient temperatures in gas or dust hazardous areas. **PPS enclosure and stainless-steel accessories allow their use in industrial or marine environments, including in cold polar areas**

**For gas hazardous areas,** this equipment is approved as “Ex-eb” and is suitable for use in zone 1 and zone 2, gas group IIC (Hydrogen/Acetylene, the highest protection group), with a temperature classification **T4 or T5 or T6**.

**For dust hazardous areas,** this equipment is approved as “Ex-tb”, suitable for use in, zone 21 and zone 22, the dust group is IIIC (electric conductive dust, the highest protection group), with ambient temperature limits on its body from **-60°C to +70°C**.

**Main use:** These enclosures have been engineered for use with flat self-temperature controlled heating cables and mounted on pipes or vertical wall or poles.

**Approvals:** These enclosures are certified: ATEX: TÜV 22 ATEX 8894 X; IECEx: IECEx TUR 22. 0059 X; CCEx: pending

**Housing:** UV-resistant PPS, diameter 150mm, maximum depth 200mm. The box also includes a long PPS foot allowing offset mounting on pipes. Waterproof class IP66. Shock resistance greater than IK10.

**Lid:** Unscrews in ¼ turn, with lock. The lid also includes a stainless-steel anti-fall chain and two holes for seals. The lid automatically locks in the closed position. It can be unlocked simply with a small flat screwdriver.

**Identification:** Riveted anodized aluminum plate, fixed to the rear wall.

**Cable glands:** A M20 cable gland and a M25 cable gland are incorporated as standard on the right side. Up to 2 tapped holes for 16, 20 or 25mm cable glands are possible on the opposite side. The leg includes a special cable gland that can accommodate up to two flat heating cables and a diastat capillary with a 6mm diameter wall penetration fitting. The leg gasket is tightened by four M6 stainless steel locking screws.

**Mounting options (both options use the same heating cable gaskets and internal fittings):**

**Y92 Series:** Pipe-mounted, via a 127mm foot, with a hose clamp (10 × 35mm opening). Maximum temperature supported by the pipe-mounted foot: 220°C

**Y93 Series:** Wall-mounted, on a pole or vertical surface, via a short 100mm foot and stainless steel mounting plate

**Optional accessories:**

- A 35mm DIN rail, useful width 70mm can be mounted on the two holes with 96.5mm distance.
- A stainless steel plate for mounting of 4mm<sup>2</sup> and 6mm<sup>2</sup> ATEX connection blocks made by JPCI.
- A stainless steel plate for mounting KA series explosion-proof thermostats is automatically included when this enclosure is ordered together with a thermostat. See references on KA thermostats pages.
- Cable glands can be fitted with special bolts for use with electrical cable protection tubes with Atex approvals.

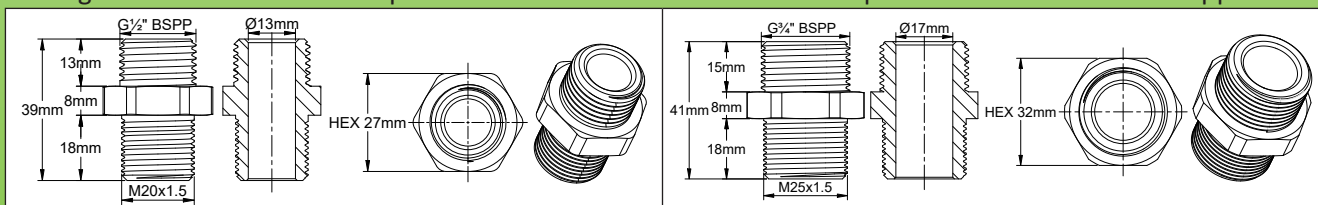

**Explosive gas class:** Ex II 2G Ex eb IIC T6/T5/T4 Gb; **Explosive dust class:** Ex II 2D Ex tb IIIC T80°C/T95°C/T125°C Db





# EX « e » round connection boxes, dia 150mm, in PPS, IP66

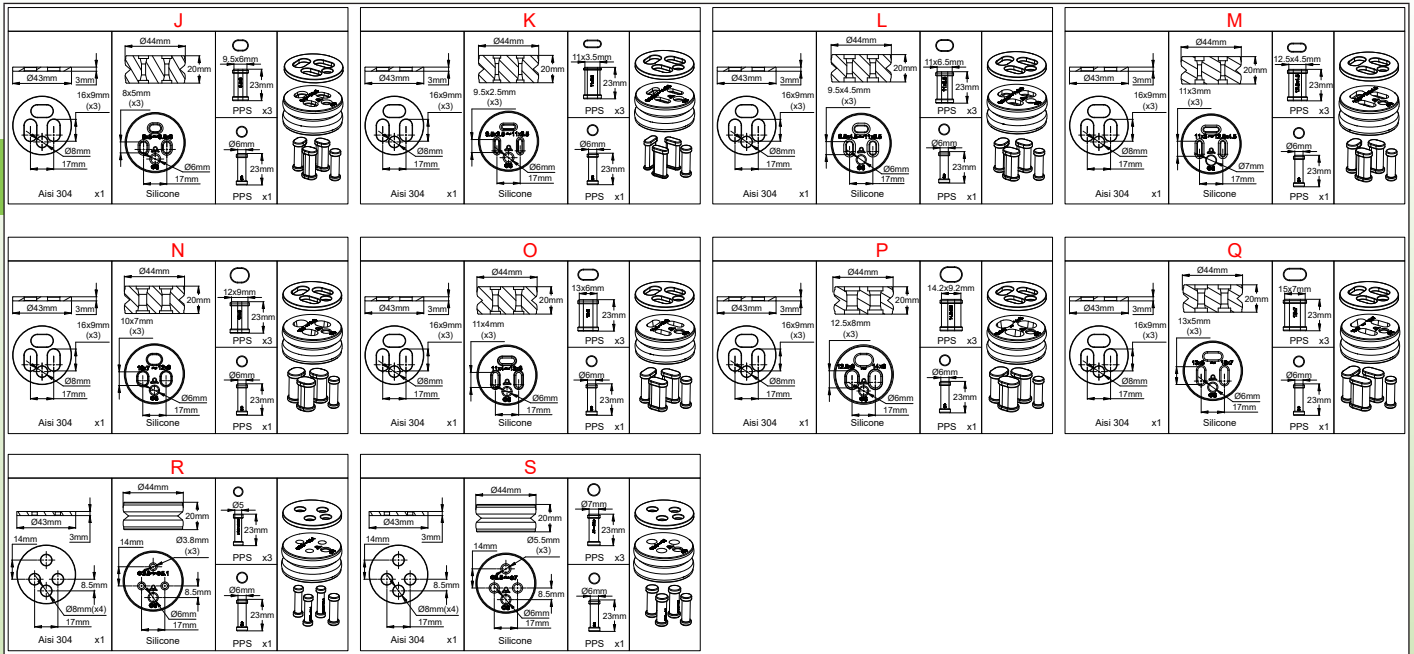

Note: one of the two flat cable hole comes with a removable shutter

**IMPORTANT NOTICE: If the enclosure is used with a thermostat inside, don't miss to add these \*\*\*\* references.**

Main connection blocks configurations (they include thermostat mounting board)

Stripping dimensions of cables\*

\*: These dimensions may vary depending of connection blocks used

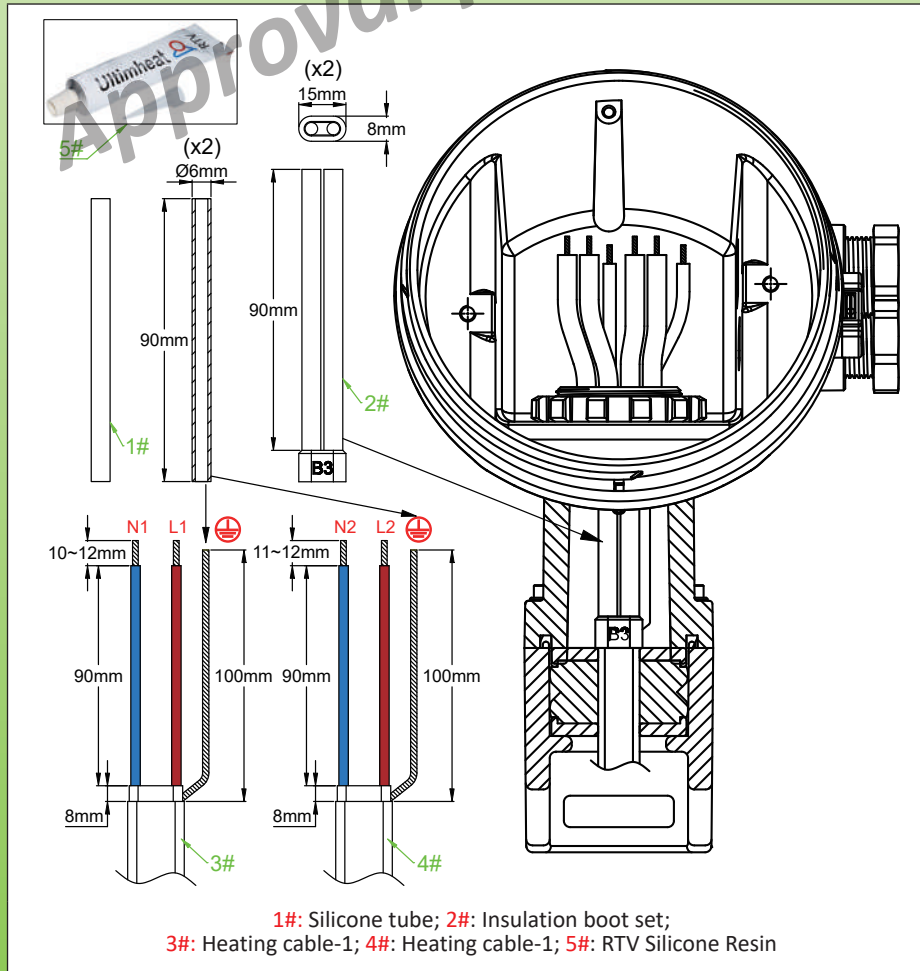

1#: Silicone tube; 2#: Insulation boot set;

3#: Heating cable-1; 4#: Heating cable-1; 5#: RTV Silicone Resin

Note: if used with temperature sensor output by the M20 cable gland, the optional NO signal cable is no more available.

# EX « e » round connection boxes, dia 150mm, in PPS, IP66

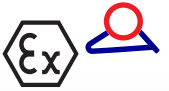

**IMPORTANT NOTICE: If these options are used, Don't miss to add these \*\*\*\*\* references**

**\*\*\*\*\* Part number of accessories in option or thermostat installed inside.**

**(For thermostat see KA thermostats pages. Ordering this enclosure with KA thermostat automatically include thermostat mounting bracket)**

D	C
Din rail 35mm, for mounting accessories or connection blocks of other suppliers	Flat rail, for mounting JPCI Atex connection blocks 6 or 4mm <sup>2</sup>

Note: this suffix is not used if no accessories

## Accessories available as spare parts (Not included in assembled products parts numbers)

Phase or neutral terminal block 4mm <sup>2</sup> in PA66, -60+120°C, maximum 25A 275V Phase: BW040BSTL Neutral: BW040BSTN	Terminal block closing plate 4mm <sup>2</sup> in PA66, -60+120°C Phase: BW040C00L Neutral: BW040C00N	Earth terminal block 4mm <sup>2</sup> in aluminum and M4 mounting screw BX040FSTM	Phase or neutral terminal block 6mm <sup>2</sup> in PA66, -60+120°C, maximum 40A 275V Phase: BW060BSTL Neutral: BW060BSTN
Terminal block closing plate 6mm <sup>2</sup> in PA66, -60+120°C Phase: BW060C00L Neutral: BW060C00N	Earth terminal block 6mm <sup>2</sup> in aluminum and M4 mounting screw BX060FSTM	Set of M3 screws for assembling terminal blocks A0, B0, C0, D0 on the thermostat body (x2) 66Y9KCBSM3	4mm <sup>2</sup> terminal block shunt 66BW040S13
6mm <sup>2</sup> terminal block shunt 66BW060S15	Internal nut wrench for pipe mounting leg. Lid tightening wrench 66Y92W1	Set of silicone protective caps to be used after stripping the heating cable conductors and their earth braid. 66Y92KLSG0	RTV silicone resin for bonding protective caps. 66Y92KLSGS

Because of permanent improvement of our products, drawings, descriptions, features used on these data sheets are for guidance only and can be modified without prior advice

## Self-regulating cables assembly steps

<p>①</p> <p>* 6YTTL04</p>	<p>②</p>
<p>1: Cut the cable, remove the external jacket on the requested length.</p>	<p>2: Unweave the braid on all this length with a tool with round edges or a screw driver. (For more details about this step #2, read the technical introduction).</p>
<p>③</p>	<p>④</p> <p>* 6YTTL04</p>
<p>3: Twist the braid to make a round wire.</p>	<p>4: Remove the electric insulation sleeving on the requested length.</p>
<p>⑤</p> <p>* 6YTTL05</p>	<p>⑥</p> <p>* 6YTTL04</p>
<p>5: Cut and remove the heating section between the two bus wires on the requested length.</p>	<p>6: Strip off the semiconductor plastic remaining on the bus wire ends to the requested length.</p>
<p>⑦</p>	<p>⑧</p>
<p>7: Cut the stripped bus wires and the ground wire to the requested length.</p>	<p>8: Place the leg on the heating cables, bringing them out from above, then if the version has a capillary outlet through the foot, slide the bulb into the 6mm hole after removing the cap until the 6mm connection fitting of the capillary comes inside the silicone seal. Then slide the first PPS compression washer, then the silicone seal onto the cables, then the second PPS compression washer. The outer insulating sheath of the heating cable should extend beyond the silicone gasket PPS compression washer.</p>

\* These exclusive tools are available in accessories section

# EX « e » round connection boxes, dia 150mm, in PPS, IP66

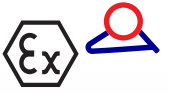

Because of permanent improvement of our products, drawings, descriptions, features used on these data sheets are for guidance only and can be modified without prior advice



**9:** Pour RTV silicone inside the main hole of the two holes silicone boot.

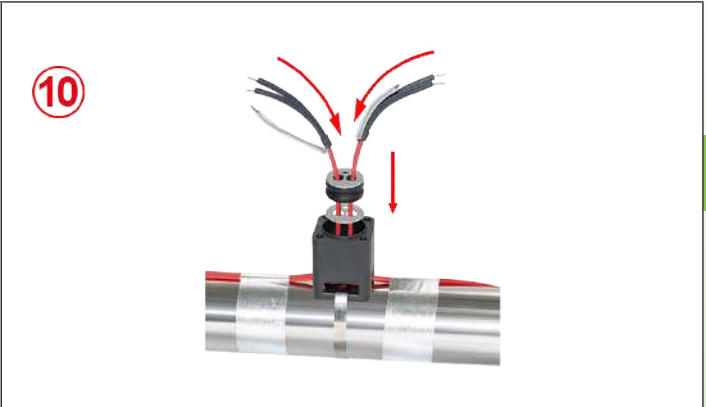

**10:** Fill the mouth of the silicone boot with silicone resin (RTV). Slide the boot over the conductors of the heating cables, leaving the earth conductor outside. Then slide the ground wires protection sleeves. These boots can also be replaced by a heat-shrinkable tube.



**11:** Compress the seal by screwing the upper part of the foot with the 4 screws until the both parts are in touch.



**12:** Place the gasket in the upper recess of the foot, then the box above. Orient the housing according to the desired position, then place and tighten the toothed nut until it locks.

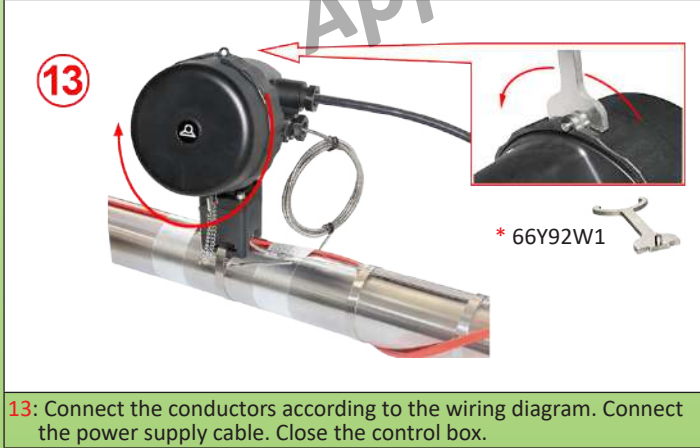

**13:** Connect the conductors according to the wiring diagram. Connect the power supply cable. Close the control box.

Approval pending

\* These exclusive tools are available in accessories section

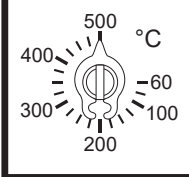
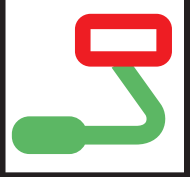
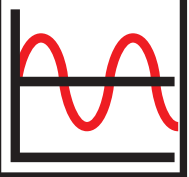
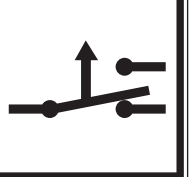
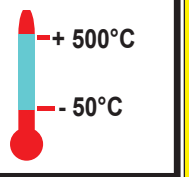

## Bulb and capillary thermostat, with set point adjustment

Electrical connection	Set point adjustment	Mounting	Action	Contact Rating 250V	T° range min and max limits	Type
Internal junction block	Printed dial	Bulb and capillary	Control	SPDT 16(4)A, 400VAC 25(4)A, 250VAC	-35~+35°C to +50~+500°C	<b>Y92KA</b> <b>Y93KA</b>
						

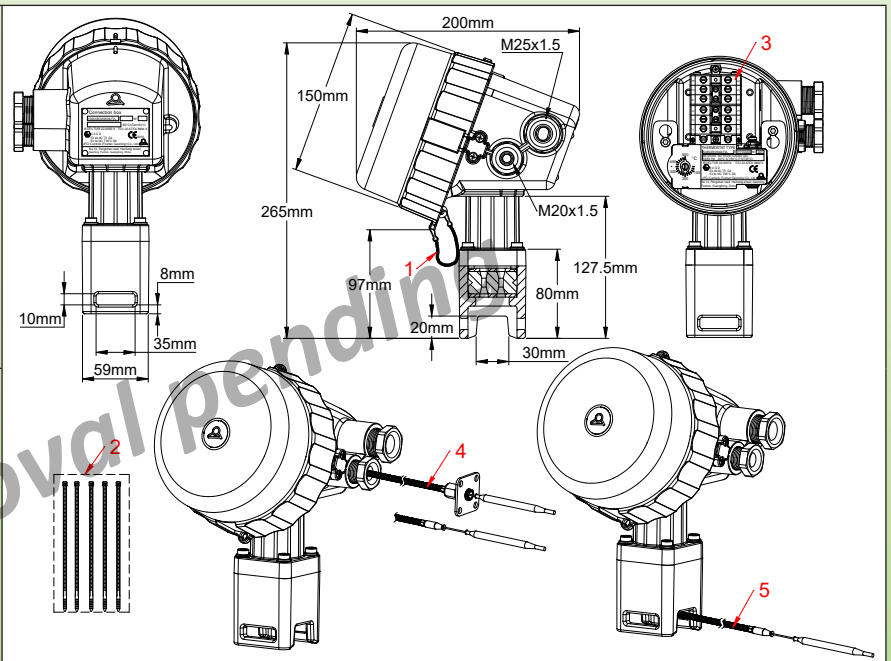

1: Lid chain, 2: Red seals, 3: Set of connection blocks, 4: Capillary output by M20 cable glands, 5: Capillary output by pipe mounting leg

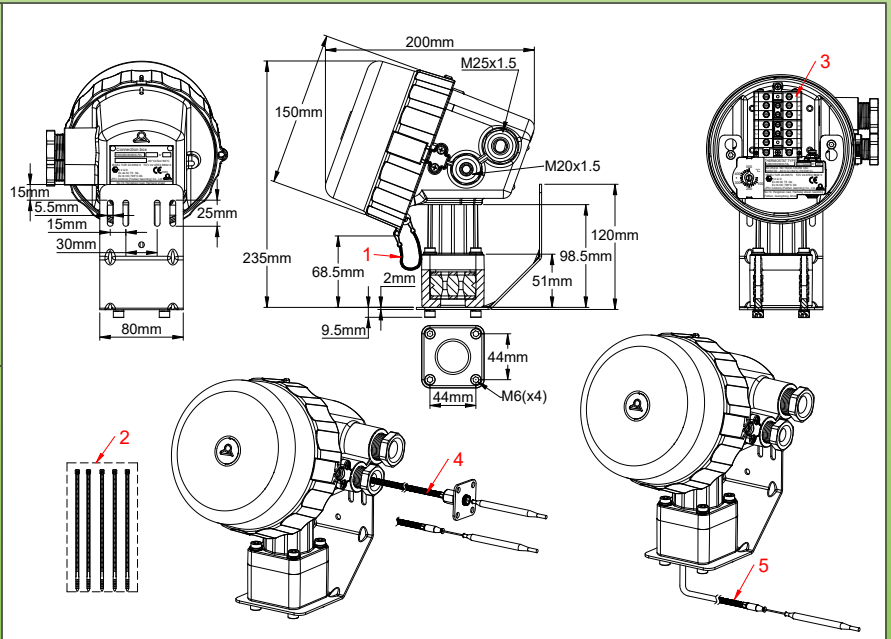

1: Lid chain, 2: Red seals, 3: Set of connection blocks, 4: Capillary output by M20 cable glands, 5: Capillary output by pipe mounting leg



Because of permanent improvement of our products, drawings, descriptions, features used on these data sheets are for guidance only and can be modified without prior advice

**Thermostatic heat tracing boxes, for wall mounting or pipes mounting, intended for the incorporation of connection blocks or mechanical or electronic thermostats.**

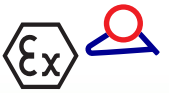

Because of permanent improvement of our products, drawings, descriptions, features used on these data sheets are for guidance only and can be modified without prior advice

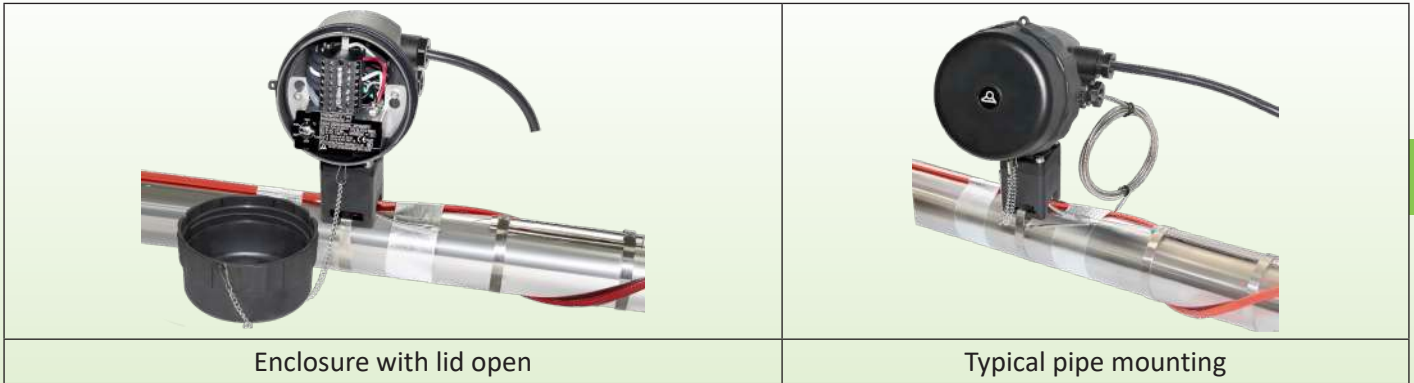

Enclosure with lid open

Typical pipe mounting

**General Rules for Installation:**

**Important Note:** These **bulb and capillary thermostats** are intended to monitor or control temperatures in gas or dust hazardous areas, by being mounted on pipes, in particular for electrical tracing applications. **PPS enclosure and stainless-steel accessories allow their use in industrial or marine environments, including in cold polar areas.**

**For gas hazardous areas,** this equipment is approved as “Ex-eb db” and is suitable for use in zone 1 and zone 2, gas group IIC (Hydrogen/Acetylene, the highest protection group), with a temperature classification **T5/T6**;

**For dust hazardous areas,** this equipment is approved as “Ex-tb”, suitable for use in zone 21 and zone 22, the dust group is IIIC (electric conductive dust, the highest protection group), with ambient temperature limits on its body from **-60°C to +60°C**. The thermostat, box and terminal block assembly is an inseparable unit.

Ambient temperature on the enclosure may also be limited by the maximum ambient temperature allowed on the temperature sensing element (See the parts numbers table).

**Approvals:** These thermostats are certified: ATEX: TÜV 22ATEX 8893 X; IECEx: TUR 22.0058X; CCCEX: pending

**Housing:** In addition to the rigorous testing required by explosion-proof equipment standards, the enclosure material was selected to provide the following environmental resistance:

- Neutral salt spray (NSS): 1008-hour tests according to DIN EN ISO9227 (corrosion tests in artificial atmospheres), the longest duration.
- UV exposure: tests according to UL746C Table 25.1 and ISO 4892

Enclosure diameter 150mm, maximum depth 200mm. It also includes a 125mm PPS foot allowing offset mounting on pipes. Waterproof class IP66. Shock resistance greater than IK10.

**Lid:** Unscrews in a ¼ turn, with lock. The lid also includes a stainless-steel anti-fall chain and two sealing holes. The lid automatically locks in the closed position. It can be unlocked simply with a small flat screwdriver.

**Temperature sensing element:** Liquid expansion bulb and capillary based on hydrocarbon oils or liquid metalloids. The capillary is protected by a corrugated flexible stainless-steel sheath.

**Adjustment:** By dial graduated in °C (°F on request). Access to the adjustment is only possible after removing the cover and turning off the power.

**Electrical connection:** On internal terminal block for conductors from 0.5mm<sup>2</sup> to 4mm<sup>2</sup>, or from 1 to 6mm<sup>2</sup> tightening by screw. There are two ground terminals on the terminal block and one on the thermostat body. See common configurations table below.

**Identification:** Unalterable anodized aluminum plate, riveted, fixed to the rear side.

**Cable glands:** An M20 cable gland and an M25 cable gland are incorporated as standard on the right side. Up to 2 tapped holes for 16, 20 or 25mm cable glands are possible on the opposite side. The foot includes a special cable gland that can accommodate up to two flat heating cables and a diastat capillary with a 6mm diameter wall penetration fitting. Tightening the foot cable gland is secured by 4 stainless steel M6 locking screws.

**Mounting options (both options use the same heating cable gaskets and internal fittings):**

**Y92 Series:** Pipe-mounted, via a 127mm foot, with a hose clamp (10x35mm opening). Maximum temperature supported by the pipe-mounted foot: 220°C

**Y93 Series:** Wall-mounted, on a pole or vertical surface, via a short 100mm foot and stainless steel mounting plate

**Contacts:** SPDT (snap action contact)

**Electrical rating:** Suitable for power control, remote control of relay coils or PLCs circuits, and direct power switching.

Voltage	Max rating (A)	Switch Electrical life (cycles)
400VAC	16	100000
250VAC	25	100000
125VAC	25	100000

These devices use silver contacts or silver alloy contacts. Due to the possible oxidation of the contacts in time, we do not recommend the use of AC or DC low-voltage circuits (24V or less) if the switched intensity is less than 100mA, or the switched power less than 800mW. Contact us for those applications that require gold-plated contacts. The electrical ratings given are normalized resistive circuit values.

**Mechanical life:** > 500.000 cycles



# Thermostatic heat tracing boxes, for wall mounting or pipes mounting, intended for the incorporation of connection blocks or mechanical or electronic thermostats.



## Optional accessories:

- A 35mm DIN rail, useful width 70mm can be mounted on the two holes with 96.5mm distance.
- A stainless steel plate for mounting of 4mm<sup>2</sup> and 6mm<sup>2</sup> ATEX connection blocks made by JPCI.
- A stainless steel plate for mounting KA series explosion-proof thermostats is automatically included when this enclosure is ordered together with a thermostat. See references on KA thermostats pages.
- Cable glands can be fitted with special bolts for use with electrical cable protection tubes with ATEX approvals.

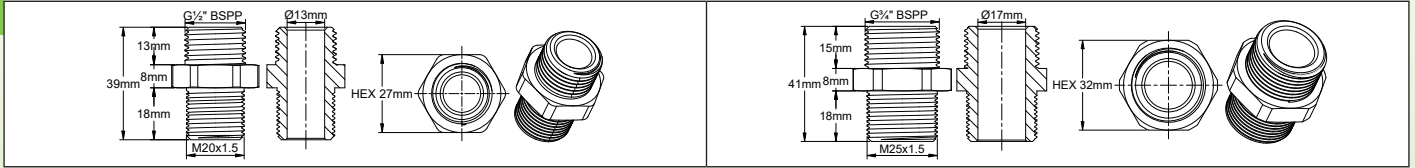

Gas classification:  $\text{Ex II 2G Ex eb db IIC T6/T5 Gb}$ ; Dust classification :  $\text{Ex II 2D Ex tb IIIC T80°C/ T95°C Db}$

## References codification

Pipes mounting, without Din rail, without connection blocks, without thermostat	Y92-*.***.***.***.***.***
Wall mounting, without Din rail, without connection blocks, without thermostat	Y93-*.***.***.***.***.***

### \* Suffixes for the definition of M20 cable gland fittings for electrical connection or capillary output

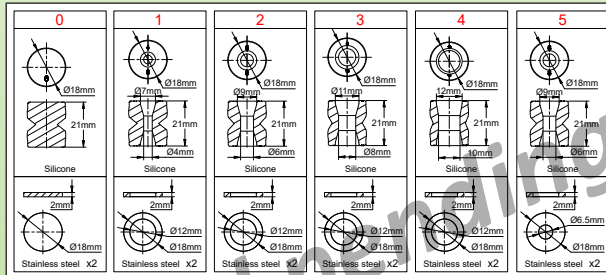

### \*\* Suffixes for the definition of M25 cable gland fittings

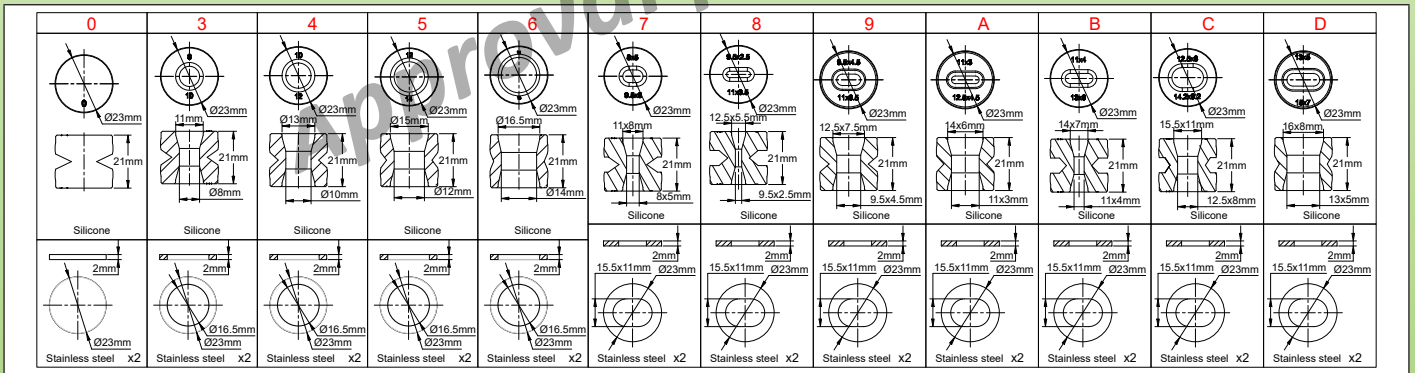

Note: these gaskets also exist for flat cables, see other models of connection boxes

### \*\*\* Suffixes for the definition of mounting leg fittings

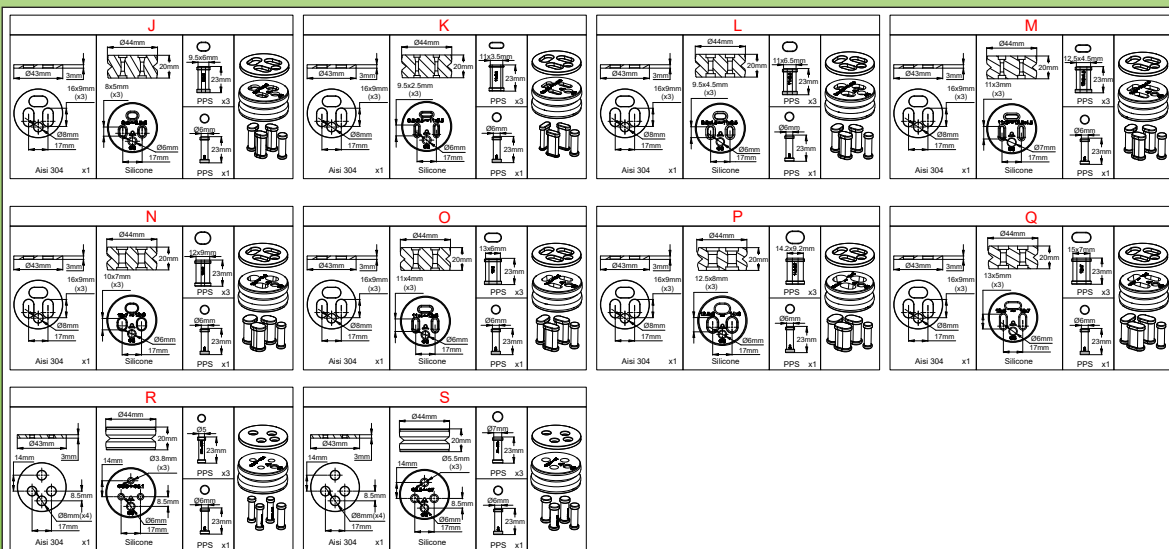

Note: one of the two flat cable hole comes with a removable shutter

Because of permanent improvement of our products, drawings, descriptions, features used on these data sheets are for guidance only and can be modified without prior advice

**IMPORTANT NOTICE:** If the enclosure is used with a thermostat inside, don't miss to add these \*\*\*\* references.

**Main connection blocks configurations (they include thermostat mounting board)**

**Type A0:** 7 terminal blocks of 6mm<sup>2</sup> assembled on the thermostat body: one earth terminal, two neutral terminals with shunt, 4 live phase terminals, including 2 with shunt, and one of which is for possible connection of the NO contact. **Use with 2 heating cable**

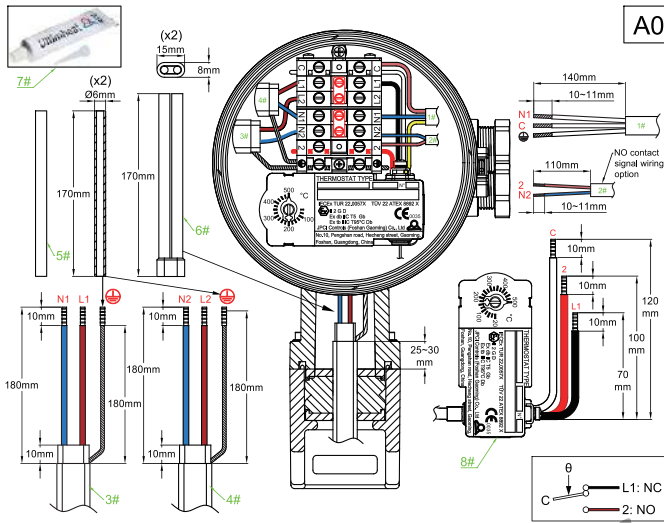

1#: power supply cable; 2#: optional NO signal cable; 3#: heating cable N°1; 4#: heating wire N°2; 5#: ground wire protection silicone sleeve; 6#: stripped heating wires insulation boot; 7#: silicone RTV resin; 8#: Thermostat (to be selected in the KA series)

**Type B0:** 7 × 4mm<sup>2</sup> terminal blocks assembled on the thermostat body: one earth terminal, two neutral terminals with shunt, 4 live phase terminals, including 2 with shunt, and one of which is for possible connection of the NO contact. **Use with 2 heating cable**

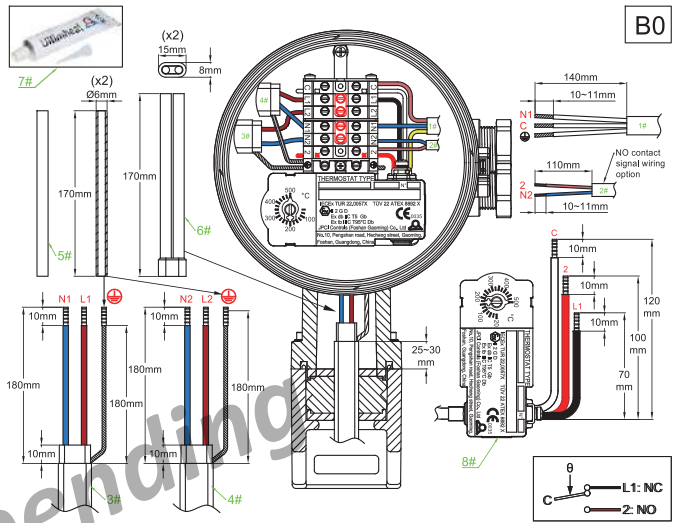

1#: power supply cable; 2#: optional NO signal cable; 3#: heating cable N°1; 4#: heating wire N°2; 5#: ground wire protection silicone sleeve; 6#: stripped heating wires insulation boot; 7#: silicone RTV resin; 8#: Thermostat (to be selected in the KA series)

**Type C0:** 6 × 6mm<sup>2</sup> terminal blocks assembled on the thermostat body: one earth terminal, two neutral terminals with shunt, 3 live phase terminals, one of which is for possible connection of the NO contact. **Use with a single heating cable**

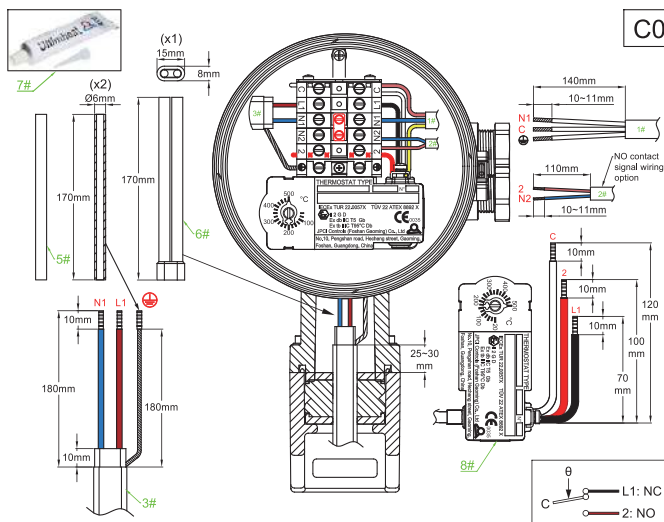

1#: power supply cable; 2#: optional NO signal cable; 3#: heating cable N°1; 4#: heating wire N°2; 5#: ground wire protection silicone sleeve; 6#: stripped heating wires insulation boot; 7#: silicone RTV resin; 8#: Thermostat (to be selected in the KA series)

**Type D0:** 6 × 4mm<sup>2</sup> terminal blocks assembled on the thermostat body: one earth terminal, two neutral terminals with shunt, 3 live phase terminals, including 2 with shunt, and one of which is for possible connection of the NO contact. **Use with 1 heating cable**

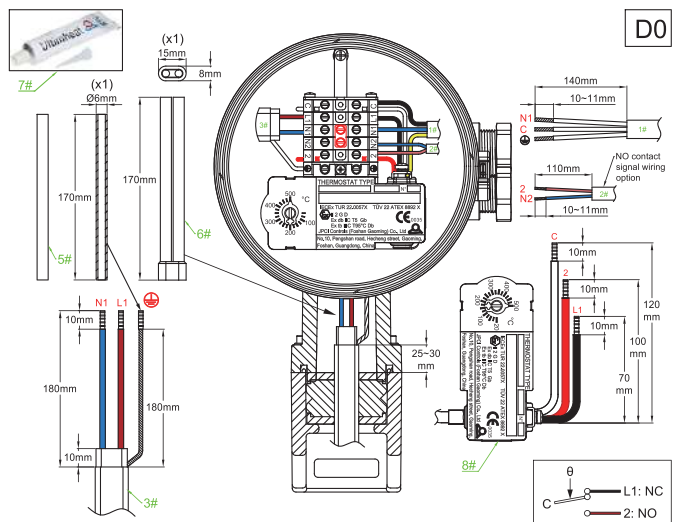

1#: power supply cable; 2#: optional NO signal cable; 3#: heating cable N°1; 4#: heating wire N°2; 5#: ground wire protection silicone sleeve; 6#: stripped heating wires insulation boot; 7#: silicone RTV resin; 8#: Thermostat (to be selected in the KA series)

Note: if used with temperature sensor output by the M20 cable gland, the optional NO signal cable is no more available.



**Accessories available as spare parts**  
(Not included in assembled products parts numbers)

<p>Phase or neutral terminal block 4mm<sup>2</sup> in PA66, -60+120°C, maximum 25A 275V</p> <p>Phase: BW040BSTL Neutral: BW040BSTN</p>	<p>Terminal block closing plate 4mm<sup>2</sup> in PA66, -60+120°C</p> <p>Phase: BW040C00L Neutral: BW040C00N</p>	<p>Earth terminal block 4mm<sup>2</sup> in aluminum and M4 mounting screw</p> <p>BX040FSTM</p>	<p>Phase or neutral terminal block 6mm<sup>2</sup> in PA66, -60+120°C, maximum 40A 275V</p> <p>Phase: BW060BSTL Neutral: BW060BSTN</p>
<p>Terminal block closing plate 6mm<sup>2</sup> in PA66, -60+120°C</p> <p>Phase: BW060C00L Neutral: BW060C00N</p>	<p>Earth terminal block 6mm<sup>2</sup> in aluminum and M4 mounting screw</p> <p>BX060FSTM</p>	<p>Set of M3 screws for assembling terminal blocks A0, B0, C0, D0 on the thermostat body (x2)</p> <p>66Y9KCBSM3</p>	<p>4mm<sup>2</sup> terminal block shunt</p> <p>66BW040S13</p>
<p>6mm<sup>2</sup> terminal block shunt</p> <p>66BW060S15</p>	<p>Internal nut wrench for pipe mounting leg. Lid tightening wrench</p> <p>66Y92W1</p>	<p>Set of silicone protective caps to be used after stripping the heating cable conductors and their earth braid.</p> <p>66Y92KLSG0</p>	<p>RTV silicone resin for bonding protective caps.</p> <p>66Y92KLSGS</p>

Because of permanent improvement of our products, drawings, descriptions, features used on these data sheets are for guidance only and can be modified without prior advice

Stripping dimensions of cables\*

\*: These dimensions may vary depending of connection blocks used

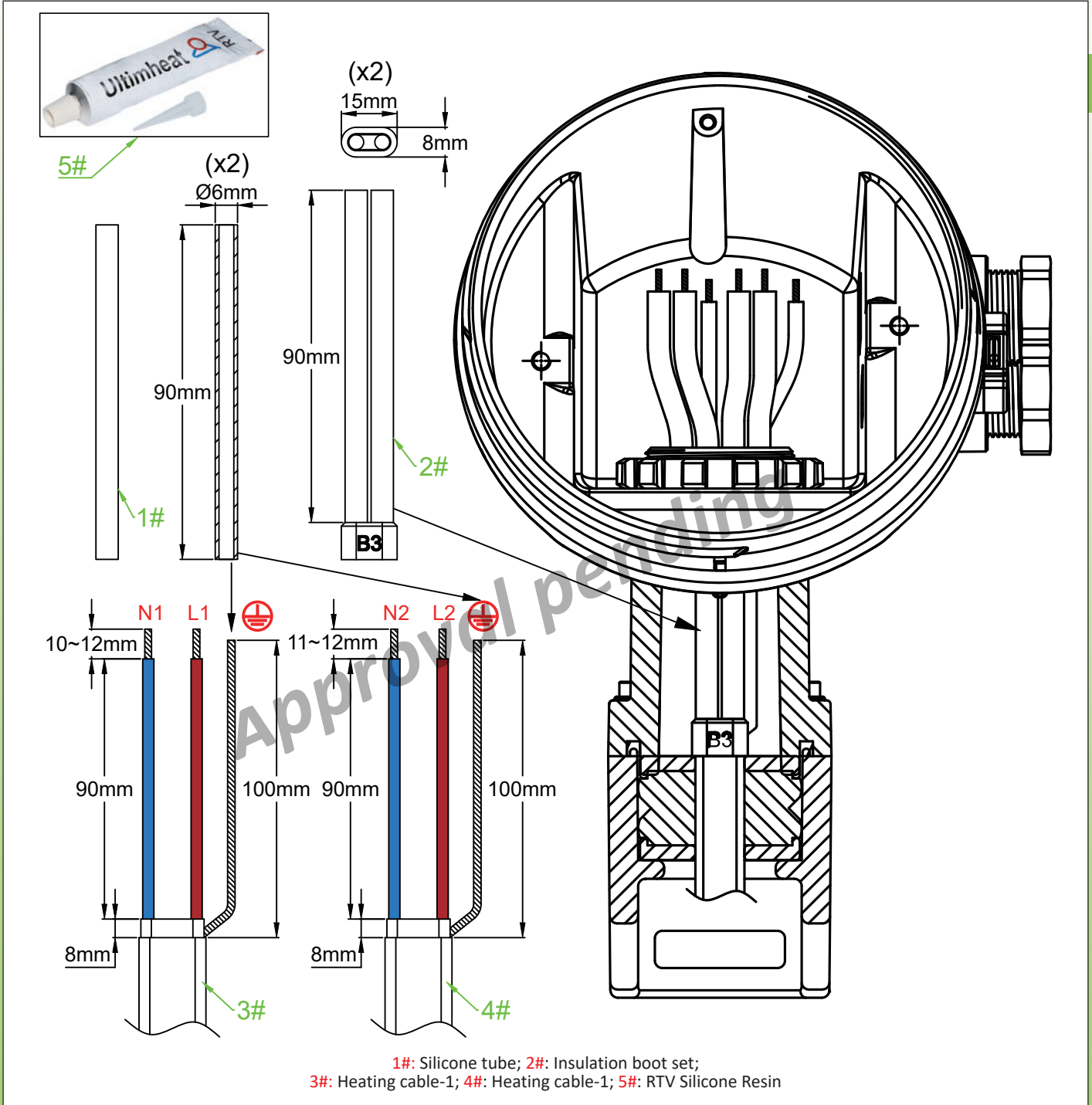





1#: Silicone tube; 2#: Insulation boot set;  
3#: Heating cable-1; 4#: Heating cable-1; 5#: RTV Silicone Resin

Note: if used with temperature sensor output by the M20 cable gland, the optional NO signal cable is no more available.

Because of permanent improvement of our products, drawings, descriptions, features used on these data sheets are for guidance only and can be modified without prior advice

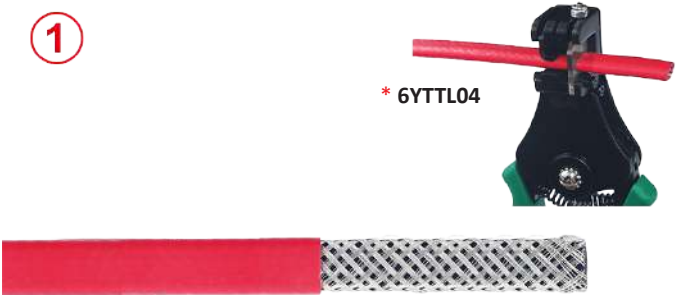

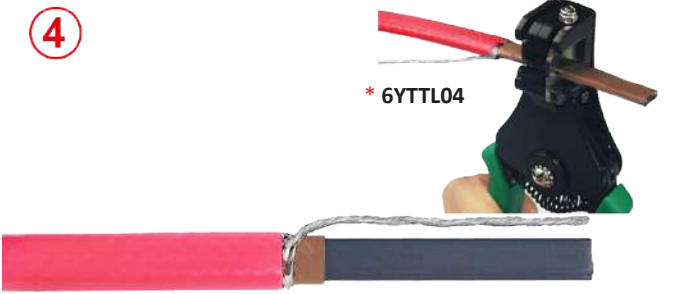
### Self-regulating cables assembly steps

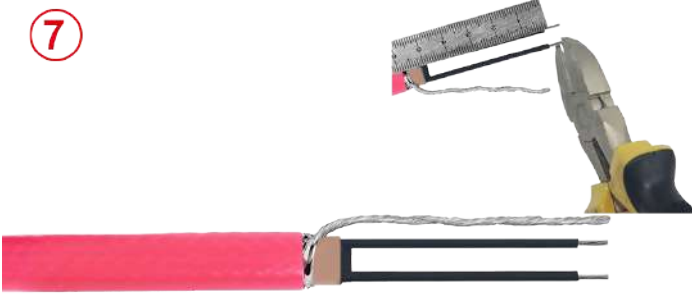
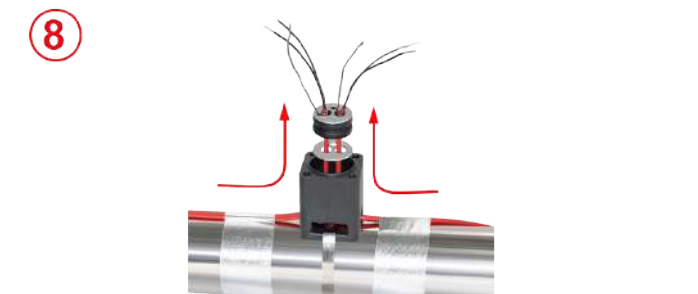
<p>①</p>  <p>* 6YTTL04</p>	<p>②</p> 
<p>1: Cut the cable, remove the external jacket on the requested length.</p>	<p>2: Unweave the braid on all this length with a tool with round edges or a screw driver. (For more details about this step #2, read the technical introduction).</p>
<p>③</p> 	<p>④</p>  <p>* 6YTTL04</p>
<p>3: Twist the braid to make a round wire.</p>	<p>4: Remove the electric insulation sleeving on the requested length.</p>
<p>⑤</p>  <p>* 6YTTL05</p>	<p>⑥</p>  <p>* 6YTTL04</p>
<p>5: Cut and remove the heating section between the two bus wires on the requested length.</p>	<p>6: Strip off the semiconductor plastic remaining on the bus wire ends to the requested length.</p>
<p>⑦</p> 	<p>⑧</p> 
<p>7: Cut the stripped bus wires and the ground wire to the requested length.</p>	<p>8: Place the leg on the heating cables, bringing them out from above, then if the version has a capillary outlet through the foot, slide the bulb into the 6mm hole after removing the cap until the 6mm connection fitting of the capillary comes inside the silicone seal. Then slide the first PPS compression washer, then the silicone seal onto the cables, then the second PPS compression washer. The outer insulating sheath of the heating cable should extend beyond the silicone gasket PPS compression washer.</p>

\* These exclusive tools are available in accessories section

Because of permanent improvement of our products, drawings, descriptions, features used on these data sheets are for guidance only and can be modified without prior advice

**Thermostatic heat tracing boxes, for wall mounting or pipes mounting, intended for the incorporation of connection blocks or mechanical or electronic thermostats.**

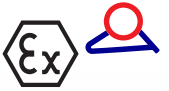

Because of permanent improvement of our products, drawings, descriptions, features used on these data sheets are for guidance only and can be modified without prior advice

<p><b>9:</b> Pour RTV silicone inside the main hole of the two holes silicone boot.</p>	<p><b>10:</b> Fill the mouth of the silicone boot with silicone resin (RTV). Slide the boot over the conductors of the heating cables, leaving the earth conductor outside. Then slide the ground wires protection sleeves. These boots can also be replaced by a heat-shrinkable tube.</p>
	<p>* 66Y92W1</p>
<p><b>11:</b> Compress the seal by screwing the upper part of the foot with the screws until the both parts are in touch</p>	<p><b>12:</b> Place the gasket in the upper recess of the foot, then the box above. Orient the housing according to the desired position, then place and tighten the toothed nut until it locks.</p>
	<p>* 66Y92W1</p>
<p><b>13:</b> <i>Step 1:</i> Assemble the KA explosion-proof thermostat on the bracket with M4 screws, torque: 1.2 N.m. <i>Step 2:</i> Fix the bracket and KA explosion-proof thermostat with two M5 screws, torque: 2 N.m. <i>Step 3:</i> Connect the heat tracing cable and power with the terminals according to the circuit diagram of A0, B0, C0, D0.</p>	<p><b>14:</b> Connect the conductors according to the wiring diagram. Connect the power supply cable. Close the control box.</p>

\* These exclusive tools are available in accessories section



Because of permanent improvement of our products, drawings, descriptions, features used on these data sheets are for guidance only and can be modified without prior advice



# Section 7

## EX « e » thermostats and connection boxes in thermoplastic PPS, IP65.



Because of permanent improvement of our products, drawings, descriptions, features used on these data sheets are for guidance only and can be modified without prior advice

Because of permanent improvement of our products, drawings, descriptions, features used on these data sheets are for guidance only and can be modified without prior advice

## Connection boxes with M20 and M25 cable glands and 35mm DIN Rail

Electrical connection	Maximum quantity of connection blocks	Maximum electrical rating	Cable glands	Mounting accessories	Min and max ambient temperature	Type
With or without Internal junction block	Up to 10 in 6mm <sup>2</sup>	25A 400V (T4/T5 self heating)	1 × M20 (Cables dia. 6 to 10mm) 1 × M25 (Cables dia. 8 to 16mm)	DIN rail 35mm	-60 to +70°C	<b>Y9A0</b>

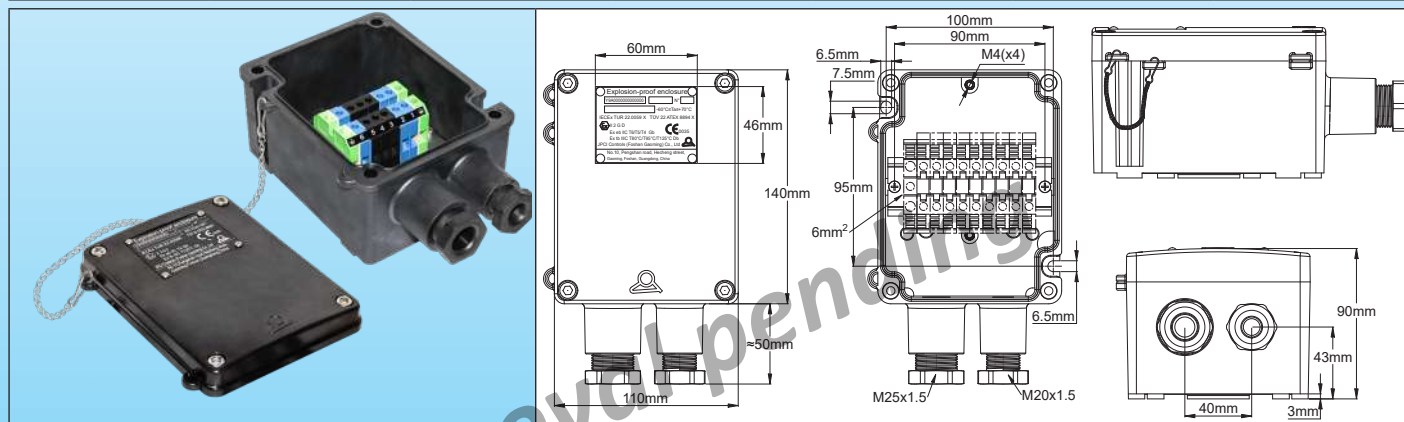

Example with connection blocks

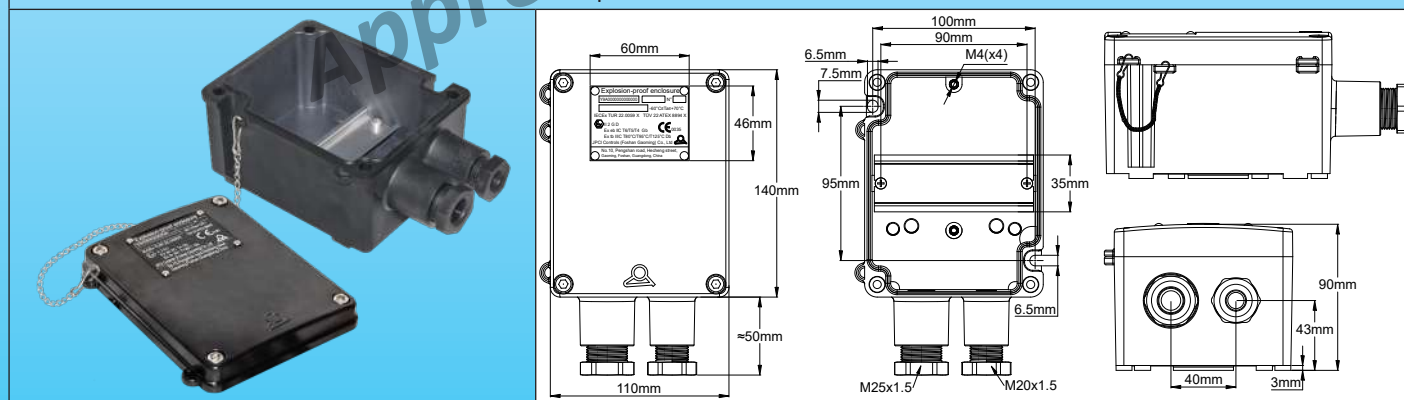

Example with only DIN rail

### General rules for installation:

**Important note:** These connection boxes are intended to be used in gas or dust hazardous areas.

**For gas hazardous areas,** this enclosure is approved as “Ex-eb” and is suitable for use in zone 1 and zone 2, gas group IIC (Hydrogen/Acetylene, the highest protection group), with a temperature classification T6/T5/T4;

**For dust hazardous areas,** this equipment is approved as “Ex-tb”, suitable for use in, zone 21 and zone 22, the dust group is IIIC (electric conductive dust, the highest protection group), maximum allowed equipment temperature 80°C/95°C/125°C.

**Important note:** PPS enclosure and stainless-steel accessories allow their use in industrial or marine environments, including in cold polar areas

**Approvals:** These enclosures are certified: ATEX: TÜV 22 ATEX 8894 X; IECEx: IECEx TUR 22. 0059 X; CCCEX: pending

**Housing:** UV-resistant PPS (according to UL746C Table 25.1). Excellent salt spray resistance: >1008h according to DIN EN ISO9227 (the highest resistance class). IP65 waterproof rating. Impact resistance greater than IK10 (Compliant with ATEX standards).

**Cover:** Mounting with four captive stainless steel screws. The cover also includes a stainless steel anti-fall chain and two holes for seals.

**Identification:** Anodized aluminum plate, fixed to the cover.

**Cable glands:** One M20 and one M25 cable gland are included as standard (see the coding for the selection of seals).



**Mounting:** Wall-mounted, with two 6.5mm diameter holes, center distance 100×95mm.

**Terminal blocks:** Up to 10 4mm<sup>2</sup> or 6mm<sup>2</sup> Exe terminal blocks from external suppliers can be snapped onto the DIN rail.

**Optional accessories:**

- A mounting plate for rail-free mounting of JPCI 4mm<sup>2</sup> or 6mm<sup>2</sup> Atex terminal blocks.
- Cable glands can be fitted with special bolts for use with electrical cable protection tubes with Atex approvals.

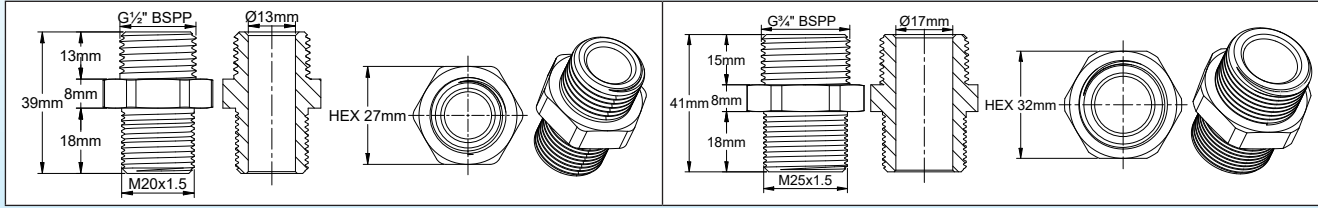

**Gas classification:** Ex II 2G Ex eb IIC T6/T5/T4 Gb; **Dust classification:** Ex II 2D Ex tb IIIC T80°C / T95°C/T125°C Db

### Part Number

Y9A0-\*\*-\*\*-\*\*-\*-\*-\*

- \* Quantity of 4mm<sup>2</sup> connection blocks (0 to 10)
- \*\* Quantity of 6mm<sup>2</sup> connection blocks (0 to 10)
- \*\*\* Suffixes for the definition of M20 cable gland fittings



0	1	2	3	4	5
Ø18mm	Ø18mm	Ø18mm	Ø18mm	Ø18mm	Ø18mm
21mm	21mm	21mm	21mm	21mm	21mm
Ø4mm	Ø7mm	Ø6mm	Ø8mm	10mm	Ø6mm
Silicone	Silicone	Silicone	Silicone	Silicone	Silicone
2mm	2mm	2mm	2mm	2mm	2mm
Ø18mm	Ø18mm	Ø18mm	Ø18mm	Ø18mm	Ø18mm
Stainless steel x2	Stainless steel x2	Stainless steel x2	Stainless steel x2	Stainless steel x2	Stainless steel x2

\*\*\*\* Suffixes for the definition of M25 cable gland fittings for round or flat cables

Ø23mm	Ø23mm	Ø23mm	Ø23mm	Ø23mm	Ø23mm
21mm	21mm	21mm	21mm	21mm	21mm
Ø8mm	Ø8mm	Ø10mm	Ø12mm	Ø14mm	Ø8x5mm
Silicone	Silicone	Silicone	Silicone	Silicone	Silicone
2mm	2mm	2mm	2mm	2mm	2mm
Ø23mm	Ø16.5mm	Ø16.5mm	Ø16.5mm	Ø16.5mm	Ø23mm
Stainless steel x2	Stainless steel x2	Stainless steel x2	Stainless steel x2	Stainless steel x2	Stainless steel x2
Ø23mm	Ø23mm	Ø23mm	Ø23mm	Ø23mm	Ø23mm
21mm	21mm	21mm	21mm	21mm	21mm
9.5x2.5mm	9.5x4.5mm	11x3mm	11x4mm	12.5x8mm	13x5mm
Silicone	Silicone	Silicone	Silicone	Silicone	Silicone
2mm	2mm	2mm	2mm	2mm	2mm
15.5x11mm	15.5x11mm	15.5x11mm	15.5x11mm	15.5x11mm	15.5x11mm
Ø23mm	Ø23mm	Ø23mm	Ø23mm	Ø23mm	Ø23mm
Stainless steel x2	Stainless steel x2	Stainless steel x2	Stainless steel x2	Stainless steel x2	Stainless steel x2

See to the last section of this catalogue for existing accessories

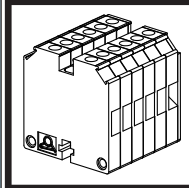
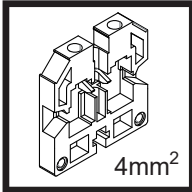
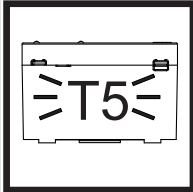
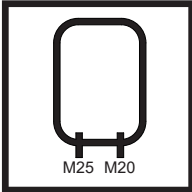
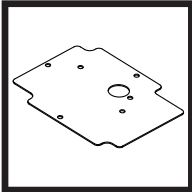
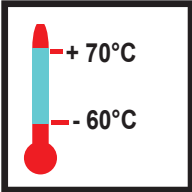
Connection boxes with one M20 and one M25 cable glands and one bulb and capillary thermostat with internal or external adjustment, capillary output on bottom side

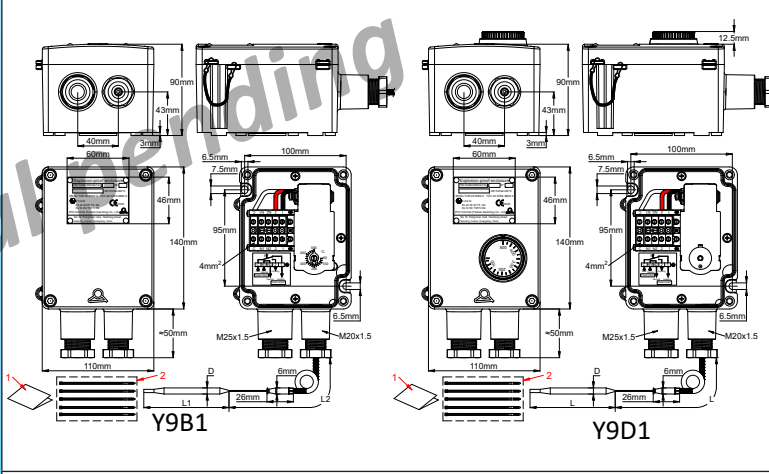
Electrical connection	Maximum quantity of connection blocks	Maximum electrical rating	Cable glands	Mounting accessories	Min and max ambient temperature	Types
On internal junction block	6 in 4 mm <sup>2</sup>	25A 400V (T5 self heating)	1 × M20 (For capillary output) 1 × M25 (For cables dia. 8 to 16mm)	Internal stainless steel mounting board	-60 to +70°C	<b>Y9B1</b> <b>Y9D1</b>
						
						<p>1. instruction manual; 2. red seals</p>

**General rules for installation:**

**Important note:** These thermostats enclosures, compatibles with our thermostats types KA, KY and KZ, are intended to monitor or control ambient temperatures in gas or dust hazardous areas.

**For gas hazardous areas,** this equipment is approved as “Ex-eb db” and is suitable for use in zone 1 and zone 2, gas group IIC (Hydrogen/Acetylene, the highest protection group), with a temperature classification T6/T5;

**For dust hazardous areas,** this equipment is approved as “Ex-tb”, suitable for use in, zone 21 and zone 22, the dust group is IIIC (electric conductive dust, the highest protection group), maximum allowed equipment temperature 80°C/95°C.

**Important note:** PPS enclosure and stainless-steel accessories allow their use in industrial or marine environments, including in cold polar areas.

The applicable ambient temperature of the equipment is:

NC: 16(4)A NO: 10(2)A, 125/250/400 VAC; 50/60 Hz; -60°C to +50°C (T6/T80°C)

NC: 16(4)A NO: 10(2)A, 125/250/400 VAC; 50/60 Hz; -60°C to +70°C (T5/T95°C)

NC: 25(4)A NO: 15(2)A, 125/250 VAC; 50/60 Hz; -60°C to +50°C (T5/T95°C)

**Approvals:** These enclosures are certified: Atex: TÜV 22 ATEX 8894 X; IECEx: IECEx TUR 22. 0059 X; CCCEX: pending

**Housing:** UV-resistant PPS (according to UL746C Table 25.1). Excellent salt spray resistance: >1008h according to DIN EN ISO9227 (the highest resistance class). IP65 waterproof rating. Impact resistance greater than IK10 (Compliant with Atex standards).

**Cover:** Mounting with four captive stainless steel screws. The cover also includes a stainless steel anti-fall chain and two holes for seals. 2 Versions are available: for internal thermostat adjustment or with outside knob set point setting.

**Identification:** Anodized aluminum plate, fixed to the cover.

**Cable glands:** One M20 cable gland for capillary output and one M25 cable gland for power connection are included as standard (see the coding for the selection of seals).

**Mounting:** Wall-mounted, with two 6.5mm diameter holes, center distance 100×95mm.

Because of permanent improvement of our products, drawings, descriptions, features used on these data sheets are for guidance only and can be modified without prior advice



**Terminal blocks:** Six 4mm<sup>2</sup> terminals blocks. Including one ground terminal, 2 neutral terminals and 3 live terminals

**Optional accessories:**

- Cable glands can be fitted with special bolts for use with electrical cable protection tubes with ATEX approvals.

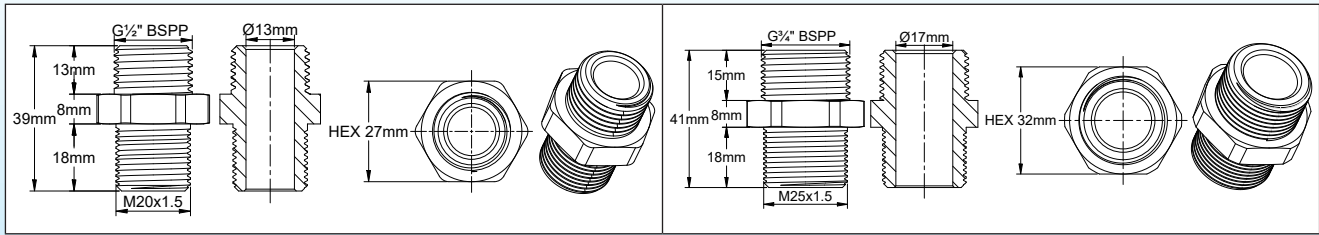

**Gas classification:** Ex II 2G Ex eb db IIC T6/T5 Gb

**Dust classification:** Ex II 2D Ex tb IIIC T80°C/T95°C Db

### Main references

Internal adjustment	Y9B1602-**-***
Outside knob adjustment	Y9D1602-**-***

### \*\* Suffixes for the definition of M25 cable gland fittings for round cables

0	1	2	3	4	5
Silicone	Silicone	Silicone	Silicone	Silicone	Silicone
Stainless steel x2	Stainless steel x2	Stainless steel x2	Stainless steel x2	Stainless steel x2	Stainless steel x2

\*\*\* Part number of thermostat installed inside: see KA thermostats pages

Because of permanent improvement of our products, drawings, descriptions, features used on these data sheets are for guidance only and can be modified without prior advice

Connection boxes with two M20 and one M25 cable glands and one bulb and capillary thermostat with internal or external adjustment, capillary output on lateral side

Electrical connection	Maximum quantity of connection blocks	Maximum electrical rating	Cable glands	Mounting accessories	Min and max ambient temperature	Types
On internal junction block	6 in 4 mm <sup>2</sup>	25A 400V (T5 self heating)	1 × M20 (For capillary output) 1 × M20 (For cables dia. 6 to 10mm) 1 × M25 (For cables dia. 8 to 16mm)	Internal stainless steel mounting board	-60 to +70°C	Y9C1 Y9E1

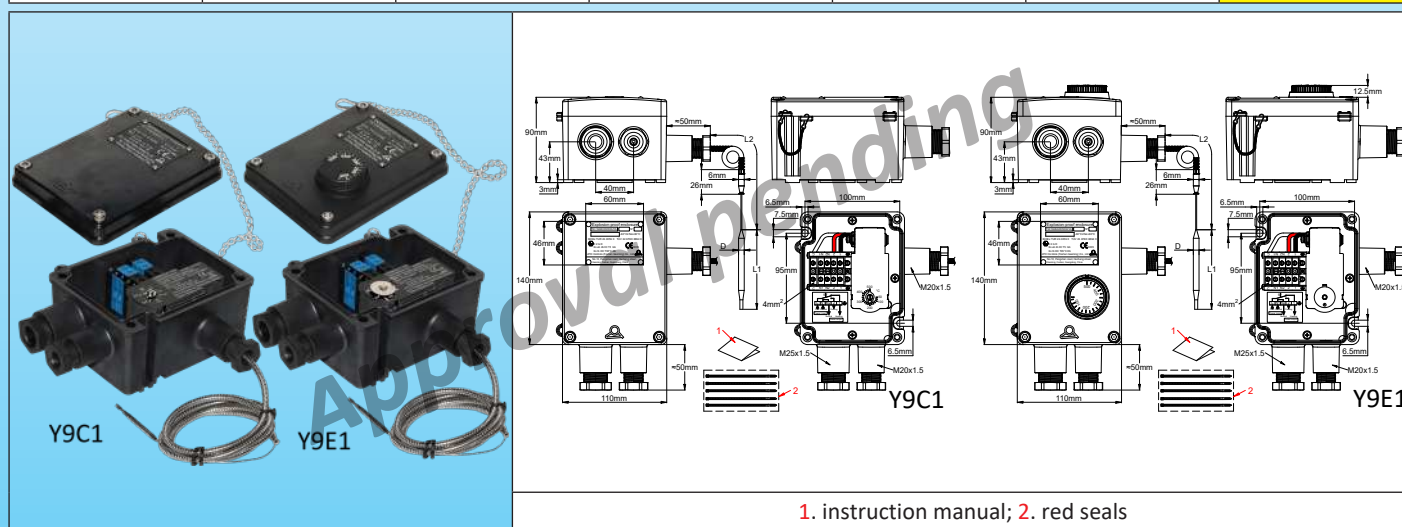

1. instruction manual; 2. red seals

**General rules for installation:**

**Important note:** These thermostats enclosures, compatible with our thermostats types KA, KY and KZ, are intended to monitor or control ambient temperatures in gas or dust hazardous areas.

**For gas hazardous areas,** this equipment is approved as “Ex-eb db” and is suitable for use in zone 1 and zone 2, gas group IIC (Hydrogen/Acetylene, the highest protection group), with a temperature classification T6/T5;

**For dust hazardous areas,** this equipment is approved as “Ex-tb”, suitable for use in, zone 21 and zone 22, the dust group is IIIC (electric conductive dust, the highest protection group), maximum allowed equipment temperature 80°C/95°C.

**Important note:** PPS enclosure and stainless-steel accessories allow their use in industrial or marine environments, including in cold polar areas

The applicable ambient temperature of the equipment is:

NC: 16(4)A NO: 10(2)A, 125/250/400 VAC; 50/60 Hz; -60°C to +50°C (T6/T80°C)

NC: 16(4)A NO: 10(2)A, 125/250/400 VAC; 50/60 Hz; -60°C to +70°C (T5/T95°C)

NC: 25(4)A NO: 15(2)A, 125/250 VAC; 50/60 Hz; -60°C to +50°C (T5/T95°C)

**Approvals:** These enclosures are certified: ATEX: TÜV 22 ATEX 8894 X; IECEx: IECEx TUR 22. 0059 X; CCEx: pending

**Housing:** UV-resistant PPS (according to UL746C Table 25.1). Excellent salt spray resistance: >1008h according to DIN EN ISO9227 (the highest resistance class). IP65 waterproof rating. Impact resistance greater than IK10 (Compliant with ATEX standards).

**Cover:** Mounting with four captive stainless steel screws. The cover also includes a stainless steel anti-fall chain and two holes for seals. 2 Versions are available: for internal thermostat adjustment or with outside knob set point setting.

**Identification:** Anodized aluminum plate, fixed to the cover.

**Cable glands:** One M20 cable gland for capillary output, one M20 cable gland for power connection, and one M25 cable gland for power connection are included as standard (see the coding for the selection of seals).

**Mounting:** Wall-mounted, with two 6.5mm diameter holes, center distance 100×95mm.

**Terminal blocks:** Six 4mm<sup>2</sup> terminals blocks. Including one ground terminal, 2 neutral terminals and 3 live terminals



### Optional accessories:

- Cable glands can be fitted with special bolts for use with electrical cable protection tubes with ATEX approvals.

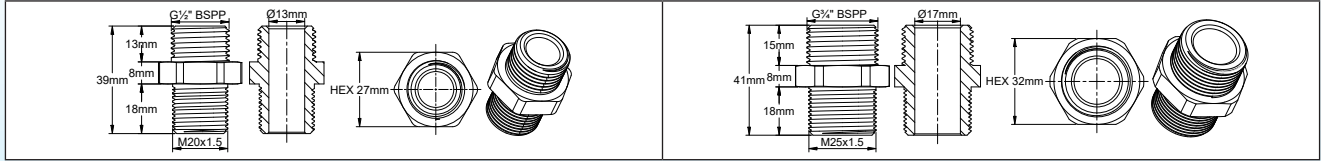

Gas classification:  $\text{Ex} \text{II} \text{2G} \text{Ex} \text{eb} \text{db} \text{IIC} \text{T6/T5} \text{Gb}$ ; Dust classification:  $\text{Ex} \text{II} \text{2D} \text{Ex} \text{tb} \text{IIIC} \text{T80}^\circ\text{C/T95}^\circ\text{C} \text{Db}$

### Main references

Internal adjustment	Y9C1602-**-**_****
Outside knob adjustment	Y9E1602-**-**_****

### \* Suffixes for the definition of M20 cable gland fittings for electrical connection

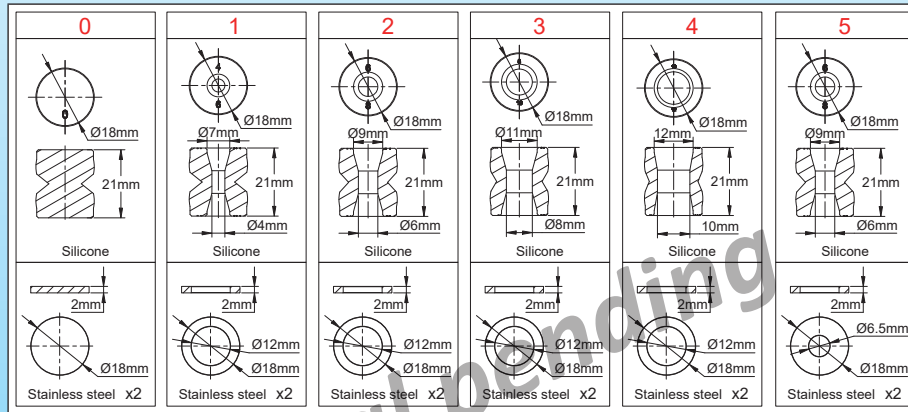

### \*\* Suffixes for the definition of M25 cable gland fittings for round or flat cables

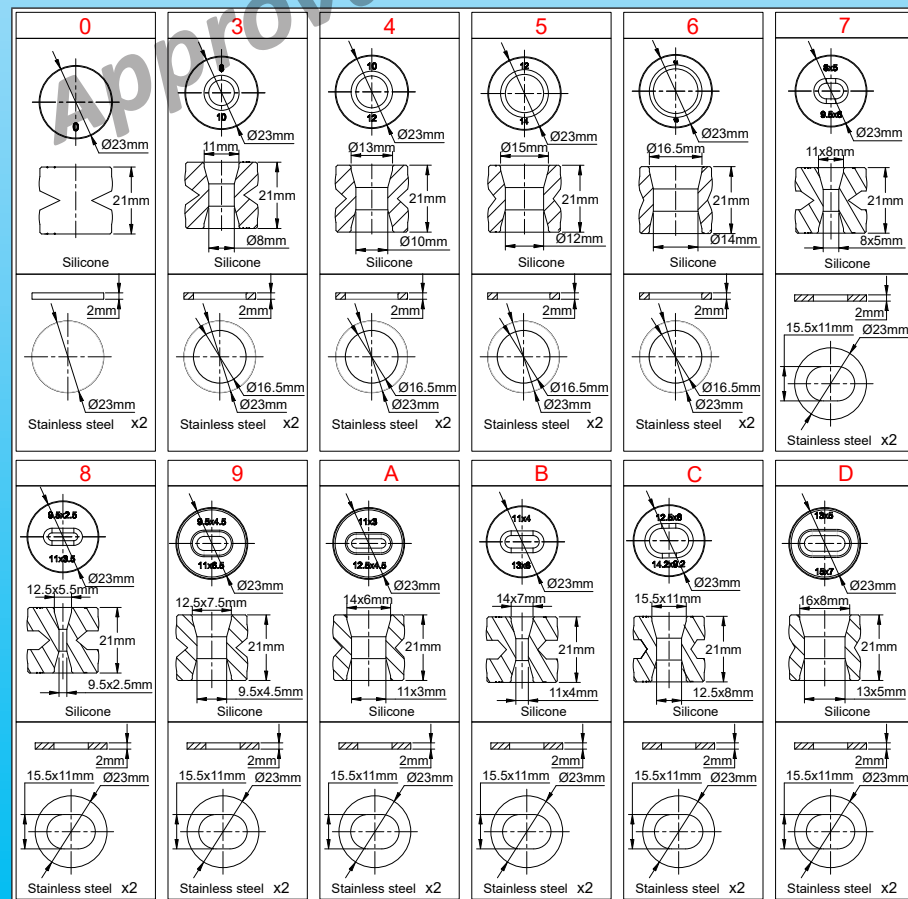

\*\*\* Part number of thermostat installed inside: see thermostats pages

Because of permanent improvement of our products, drawings, descriptions, features used on these data sheets are for guidance only and can be modified without prior advice

Connection boxes with two M20 and one M25 cable glands and one bulb and capillary thermostat with internal or external adjustment, capillary output on lateral side, **ambient temperature bulb**

Electrical connection	Maximum quantity of connection blocks	Maximum electrical rating	Cable glands	Mounting accessories	Min and max ambient temperature	Types
On internal junction block	6 in 4 mm <sup>2</sup>	25A 400V (T5 self-heating)	1 × M20 (Vor capillary output) 1 × M20 (For cables dia. 6 to 10mm) 1 × M25 (For cables dia. 8 to 16mm)	Internal stainless steel mounting board	-60 to +70°C	<b>Y9C3</b> <b>Y9E3</b>

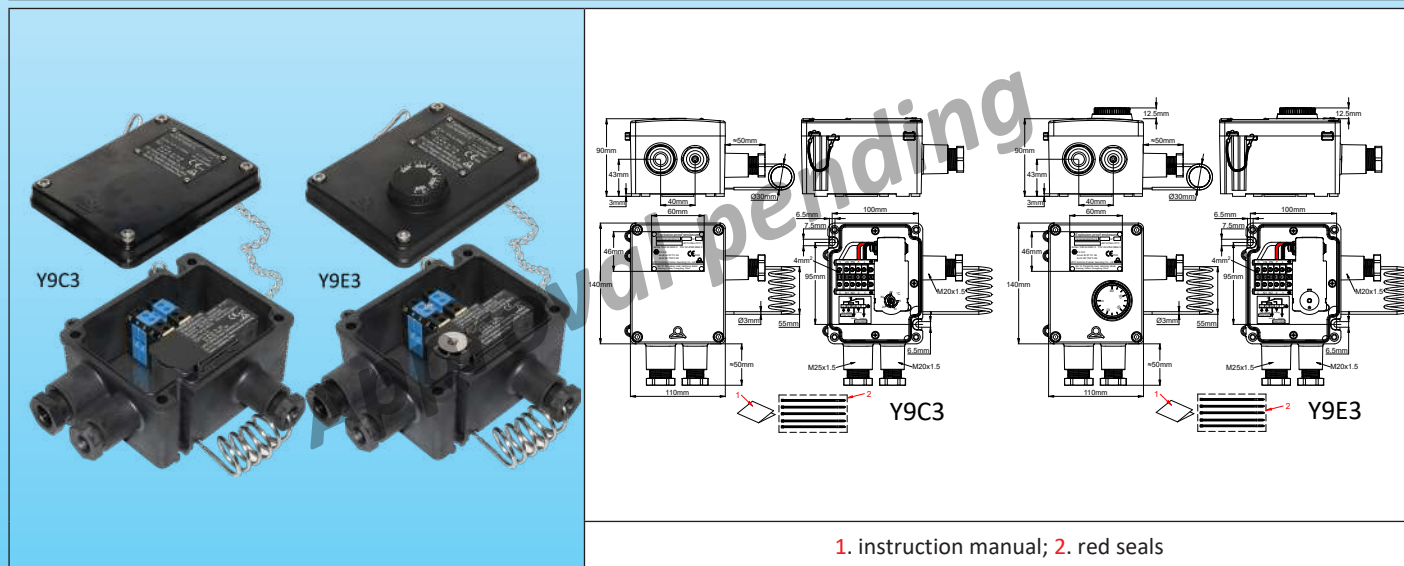

**General rules for installation:**

**Important note:** These thermostats enclosures, compatibles with our thermostats types KA, KY and KZ, are intended to monitor or control ambient temperatures in gas or dust hazardous areas.

**For gas hazardous areas,** this equipment is approved as “Ex-eb db” and is suitable for use in zone 1 and zone 2, gas group IIC (Hydrogen/Acetylene, the highest protection group), with a temperature classification **T6/T5**.

**For dust hazardous areas,** this equipment is approved as “Ex-tb”, suitable for use in, zone 21 and zone 22, the dust group is IIIC (electric conductive dust, the highest protection group), maximum allowed equipment temperature **80°C/95°C**.

**Important note:** PPS enclosure and stainless-steel accessories allow their use in industrial or marine environments, including in cold polar areas

The applicable ambient temperature of the equipment is:

NC: 16(4)A NO: 10(2)A, 125/250/400 VAC; 50/60 Hz; -60°C to +50°C (T6/T80°C)

NC: 16(4)A NO: 10(2)A, 125/250/400 VAC; 50/60 Hz; -60°C to +70°C (T5/T95°C)

**Approvals:** These enclosures are certified: ATEX: TÜV 22 ATEX 8894 X; IECEx: IECEx TUR 22. 0059 X; CCCEx: pending

**Housing:** UV-resistant PPS (according to UL746C Table 25.1). Excellent salt spray resistance: >1008h according to DIN EN ISO9227 (the highest resistance class). IP65 waterproof rating. Impact resistance greater than IK10 (Compliant with ATEX standards). **They allow the mounting on the side of coiled bulbs for ambient temperature measurement**

**Cover:** Mounting with four captive stainless steel screws. The cover also includes a stainless steel anti-fall chain and two holes for seals. 2 Versions are available: **for internal thermostat adjustment or with outside knob set point setting.**

**Identification:** Anodized aluminum plate, fixed to the cover.

**Cable glands:** One M20 cable gland for capillary output, one M20 cable gland for power connection, and one M25 cable gland for power connection are included as standard (see the coding for the selection of seals).

**Mounting:** Wall-mounted, with two 6.5mm diameter holes, center distance 100×95mm.

**Terminal blocks:** Six 4mm<sup>2</sup> terminals blocks. Including one ground terminal, 2 neutral terminals and 3 live terminals



### Optional accessories:

- Cable glands can be fitted with special bolts for use with electrical cable protection tubes with Atex approvals.

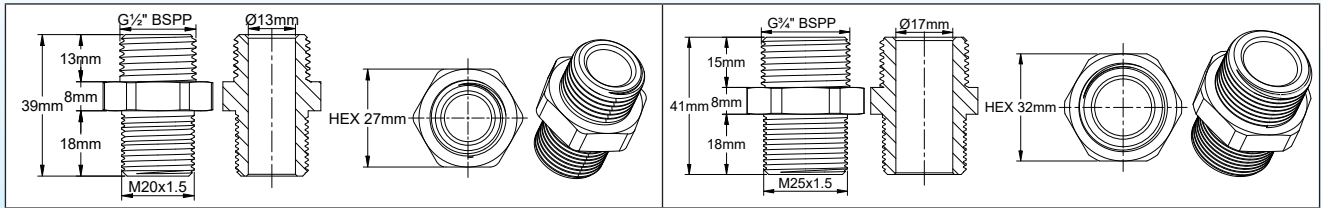

Gas classification:  $\text{Ex II 2G Ex eb db IIC T6/T5 Gb}$ ; Dust classification:  $\text{Ex II 2D Ex tb IIIC T80°C/T95°C Db}$

### Main references

Internal adjustment	Y9C3602-**-**-***
Outside knob adjustment	Y9E3602-**-**-***

### \* Suffixes for the definition of M20 cable gland fittings for electrical connection

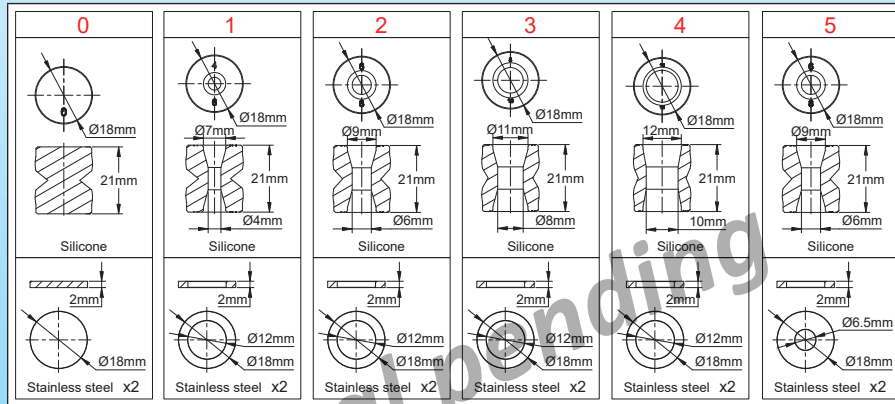

### \*\* Suffixes for the definition of M25 cable gland fittings for round or flat cables

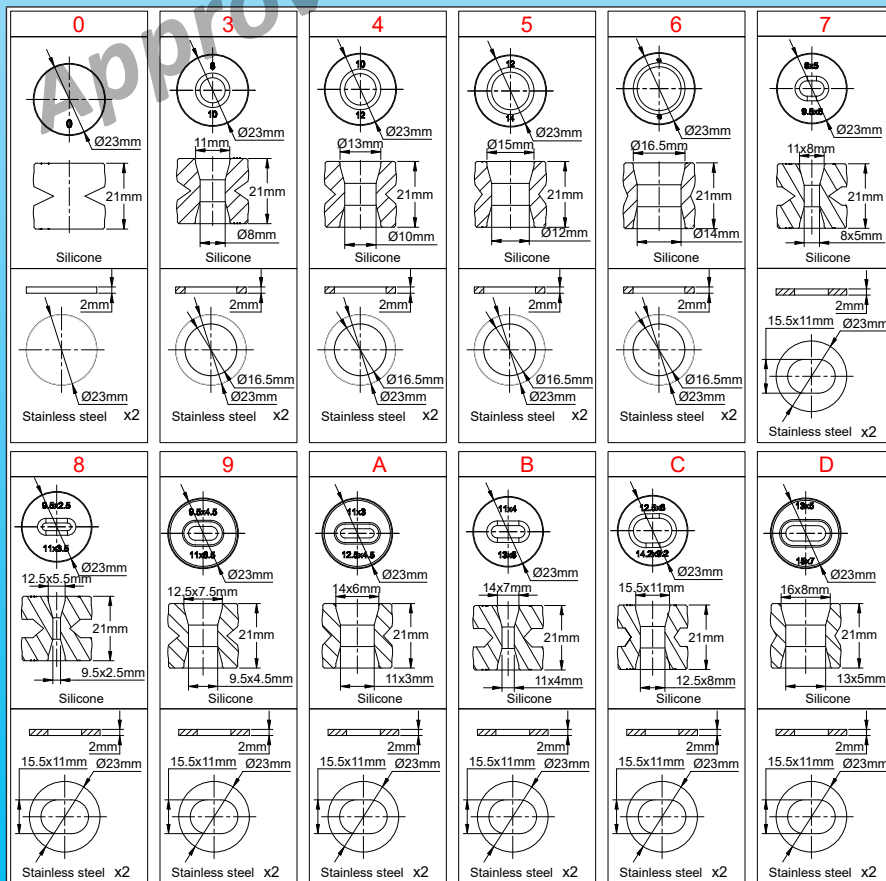

\*\*\* Part number of thermostat installed inside: see KA thermostats pages

Connection boxes with one M20 and one M25 cable glands and one bulb and capillary thermostat with internal or external adjustment, temperature sensing by backside rod without fins

Electrical connection	Maximum quantity of connection blocks	Maximum electrical rating	Cable glands	Mounting accessories	Min and max ambient temperature	Types
On internal junction block	6 in 4 mm <sup>2</sup>	25A 400V (T5 self-heating)	1 × M20 (For cables dia 6 to 10mm) 1 × M25 (For cables dia. 8 to 16mm)	Internal stainless steel mounting board	-60 to +70°C	Y9B5 Y9E5

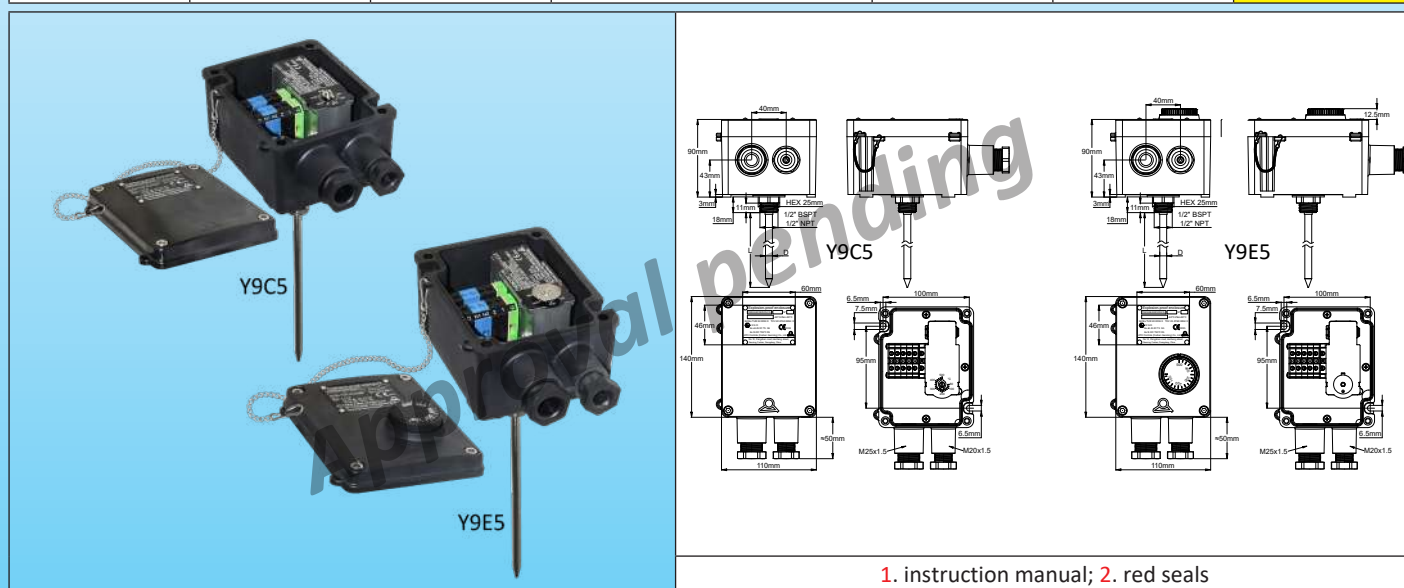

1. instruction manual; 2. red seals

**General rules for installation:**

**Important note:** These thermostats enclosures, compatibles with our thermostats types KA, KY and KZ, are intended to monitor or control ambient temperatures in gas or dust hazardous areas.

**For gas hazardous areas,** this equipment is approved as “Ex-eb db” and is suitable for use in zone 1 and zone 2, gas group IIC (Hydrogen/Acetylene, the highest protection group), with a temperature classification T6/T5.

**For dust hazardous areas,** this equipment is approved as “Ex-tb”, suitable for use in, zone 21 and zone 22, the dust group is IIIC (electric conductive dust, the highest protection group), maximum allowed equipment temperature 80°C/95°C.

**Important note:** PPS enclosure and stainless-steel accessories allow their use in industrial or marine environments, including in cold polar areas

The applicable ambient temperature of the equipment is:

NC: 16(4)A NO: 10(2)A, 125/250/400 VAC; 50/60 Hz; -60°C to +50°C (T6/T80°C)

NC: 16(4)A NO: 10(2)A, 125/250/400 VAC; 50/60 Hz; -60°C to +70°C (T5/T95°C)

NC: 25(4)A NO: 15(2)A, 125/250 VAC; 50/60 Hz; -60°C to +50°C (T5/T95°C)

**Approvals:** These enclosures are certified: Atex: TÜV 22 ATEX 8894 X; IECEx: IECEx TUR 22. 0059 X; CCCEx: pending

**Housing:** UV-resistant PPS (according to UL746C Table 25.1). Excellent salt spray resistance: >1008h according to DIN EN ISO9227 (the highest resistance class). IP65 waterproof rating. Impact resistance greater than IK10 (Compliant with Atex standards). **They allow the mounting on the bottom, of direct temperature sensing rods, for liquids temperature measurement up to 95°C**

**Cover:** Mounting with four captive stainless steel screws. The cover also includes a stainless steel anti-fall chain and two holes for seals. 2 Versions are available: **for internal thermostat adjustment or with outside knob set point setting.**

**Identification:** Anodized aluminum plate, fixed to the cover.

**Cable glands:** One M20 cable gland for power connection, and one M25 cable gland for power connection are included as standard (see the coding for the selection of seals).

**Mounting:** By the thread on the rod fitting.

**Terminal blocks:** Six 4mm<sup>2</sup> terminals blocks. Including one ground terminal, 2 neutral terminals and 3 live terminals

Because of permanent improvement of our products, drawings, descriptions, features used on these data sheets are for guidance only and can be modified without prior advice



### Optional accessories:

- Cable glands can be fitted with special bolts for use with electrical cable protection tubes with Atex approvals.

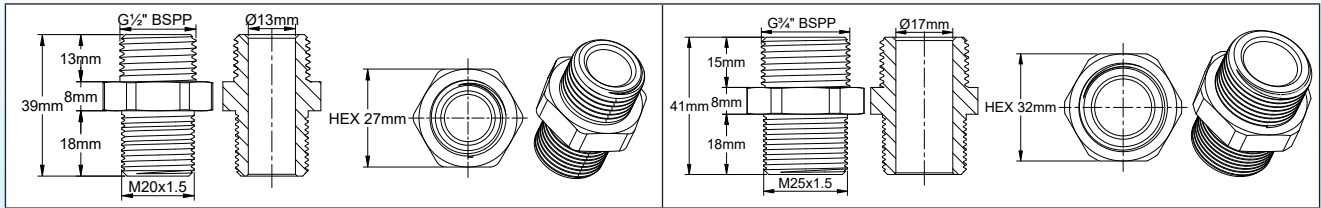

Gas classification:  $\text{Ex II 2G Ex eb db IIC T6/T5 Gb}$ ; Dust classification:  $\text{Ex II 2D Ex tb IIIC T80°C/T95°C Db}$

### Main references

Internal adjustment	Y9B560-**-**_**_*-****
Outside knob adjustment	Y9E560-**-**_**_*-****

### \* Suffixes for the definition of M20 cable gland fittings for electrical connection

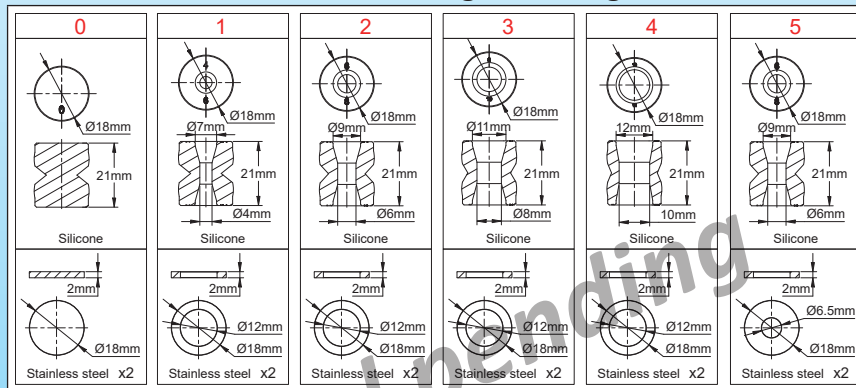

### \*\* Suffixes for the definition of M25 cable gland fittings for round or flat cables

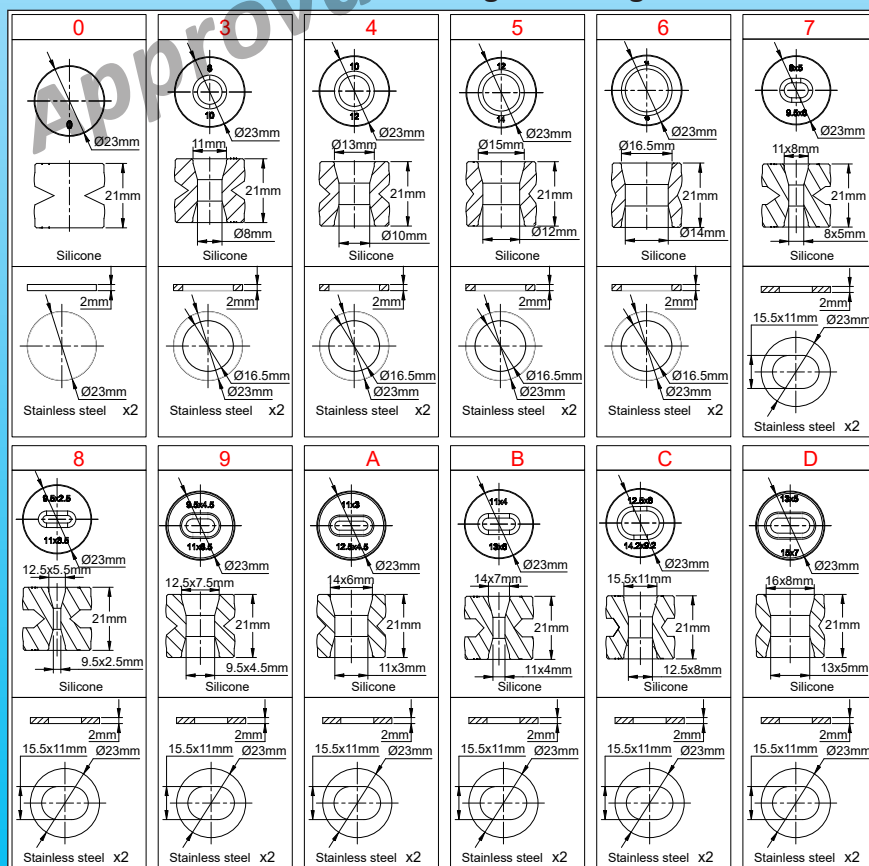

\*\*\* Length of the rod under the fitting, measured in mm

\*\*\*\* Part number of thermostat installed inside: see thermostats pages



Because of permanent improvement of our products, drawings, descriptions, features used on these data sheets are for guidance only and can be modified without prior advice

**Connection boxes with two M20 and one M25 cable glands and one bulb and capillary thermostat with internal or external adjustment, temperature sensing by backside rod **with fins****

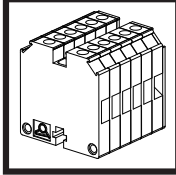
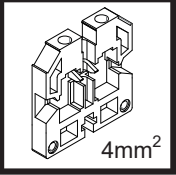
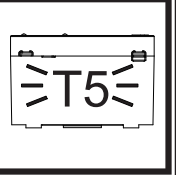
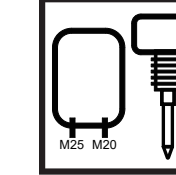
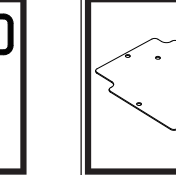
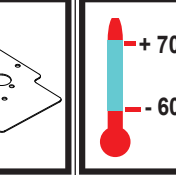
Electrical connection	Maximum quantity of connection blocks	Maximum electrical rating	Cable glands	Mounting accessories	Min and max ambient temperature	Types
On internal junction block	6 in 4 mm <sup>2</sup>	25A 400V (T5 self-heating)	1 × M20 (For cables dia 6 to 10mm) 1 × M25 (For cables dia. 8 to 16mm)	Internal stainless steel mounting board	-60 to +70°C	<b>Y9B6</b> <b>Y9E6</b>
						

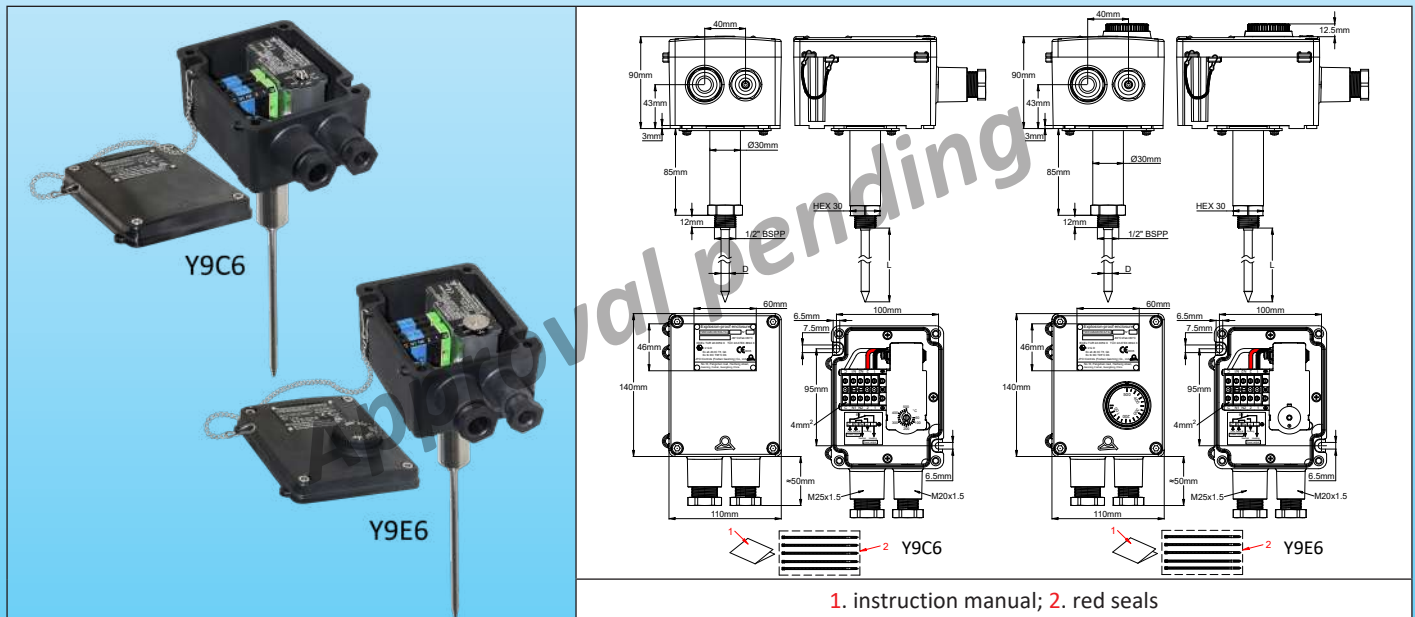

**General rules for installation:**

**Important note:** These thermostats enclosures, compatibles with our thermostats types KA, KY and KZ, are intended to monitor or control ambient temperatures in gas or dust hazardous areas.

**For gas hazardous areas,** this equipment is approved as “Ex-eb db” and is suitable for use in zone 1 and zone 2, gas group IIC (Hydrogen/Acetylene, the highest protection group), with a temperature classification **T6/T5**.

**For dust hazardous areas,** this equipment is approved as “Ex-tb”, suitable for use in, zone 21 and zone 22, the dust group is IIC (electric conductive dust, the highest protection group), maximum allowed equipment temperature **80°C/95°C**.

**Important note:** PPS enclosure and stainless-steel accessories allow their use in industrial or marine environments, including in cold polar areas.

The applicable ambient temperature of the equipment is:

NC: 16(4)A NO: 10(2)A, 125/250/400 VAC; 50/60 Hz; -60°C to +50°C (T6/T80°C)

NC: 16(4)A NO: 10(2)A, 125/250/400 VAC; 50/60 Hz; -60°C to +70°C (T5/T95°C)

NC: 25(4)A NO: 15(2)A, 125/250 VAC; 50/60 Hz; -60°C to +50°C (T5/T95°C)

**Approvals:** These enclosures are certified: Atex: TÜV 22 ATEX 8894 X; IECEx: IECEx TUR 22. 0059 X; CCCEX: pending

**Housing:** UV-resistant PPS (according to UL746C Table 25.1). Excellent salt spray resistance: >1008h according to DIN EN ISO9227 (the highest resistance class). IP65 waterproof rating. Impact resistance greater than IK10 (Compliant with Atex standards). **They allow the mounting on the bottom, of direct temperature sensing rods, for liquids or gas temperature measurement up to 300°C**

**Cover:** Mounting with four captive stainless steel screws. The cover also includes a stainless steel anti-fall chain and two holes for seals. 2 Versions are available: **for internal thermostat adjustment or with outside knob set point setting.**

**Identification:** Anodized aluminum plate, fixed to the cover.

**Cable glands:** One M20 cable for power connection, and one M25 cable gland for power connection are included as standard (see the coding for the selection of seals).



**Mounting:** By the thread on the rod fitting.

**Terminal blocks:** Six 4mm<sup>2</sup> terminals blocks. Including one ground terminal, 2 neutral terminals and 3 live terminals

**Optional accessories:**

- Cable glands can be fitted with special bolts for use with electrical cable protection tubes with ATEX approvals.

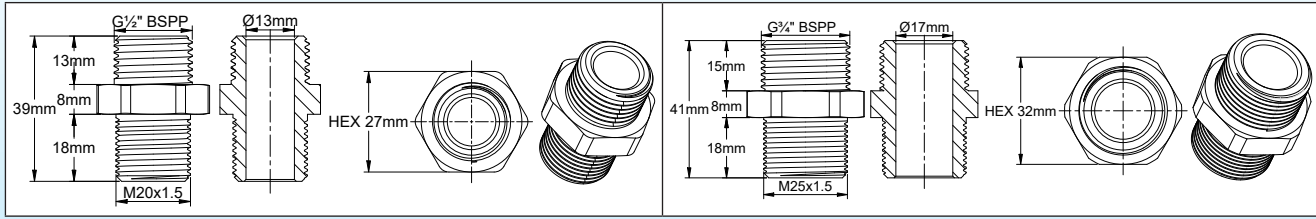

Gas classification:  $\text{Ex} \text{II} 2\text{G Ex eb db IIC T6/T5 Gb}$

Dust classification:  $\text{Ex} \text{II} 2\text{D Ex tb IIIC T80}^\circ\text{C/T95}^\circ\text{C Db}$

## Main references

Internal adjustment	Y9B660-*.***_***_****
Outside knob adjustment	Y9E660-*.***_***_****

\* Suffixes for the definition of M20 cable gland fittings for electrical connection

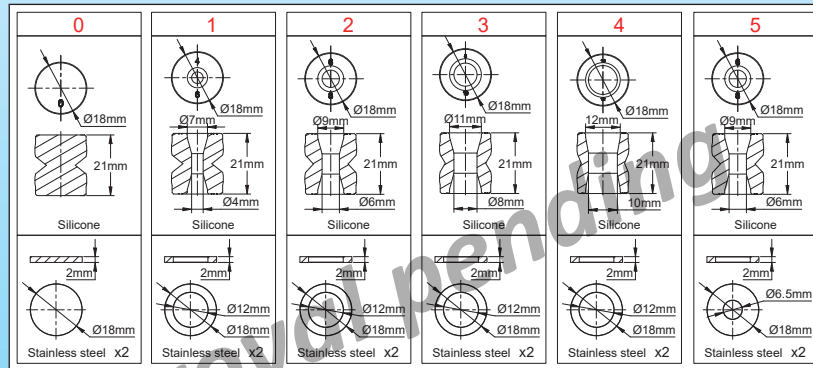

\*\* Suffixes for the definition of M25 cable gland fittings for round or flat cables

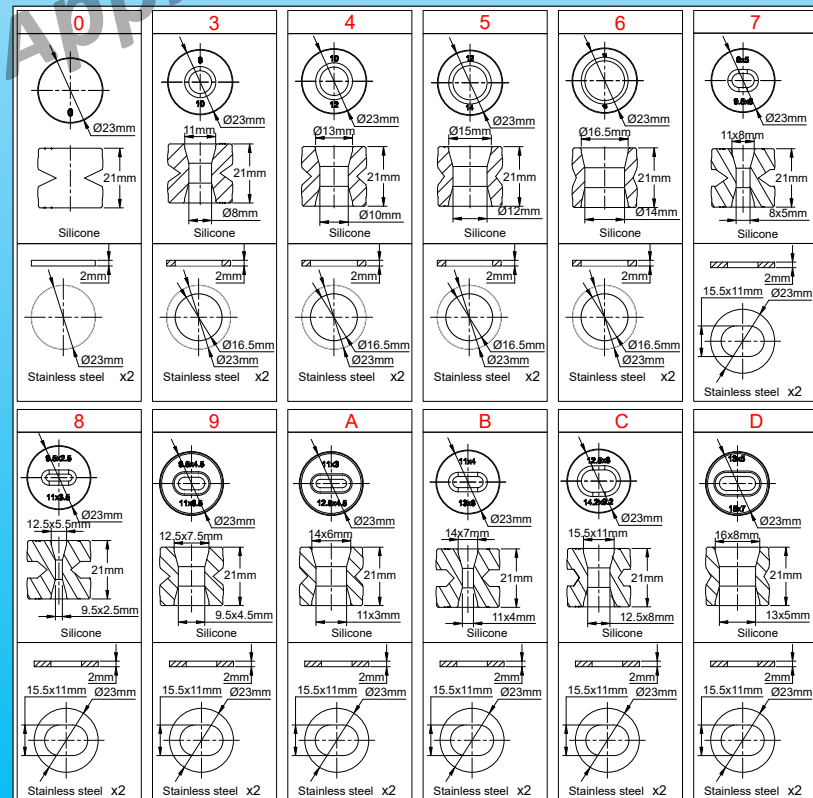



\*\*\* Length of the rod under the fitting, measured in mm

\*\*\*\* Part number of thermostat installed inside: see thermostats pages

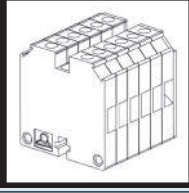

Because of permanent improvement of our products, drawings, descriptions, features used on these data sheets are for guidance only and can be modified without prior advice

## Connection boxes, with ambient thermostat, fixed temperature setting

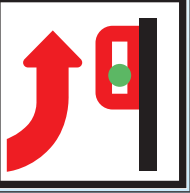
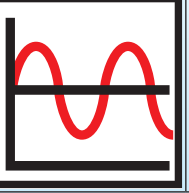
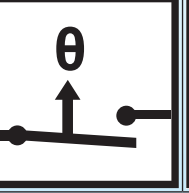
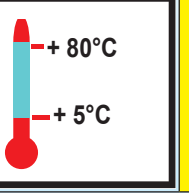
Electrical connection	Set point adjustment	Mounting	Action	Contact Rating 240V	Min. and max. of calibration	Type
Internal junction block	Fixed setting	Wall	Limiter	Open on temperature rise 10A	5 to +80°C	Y9TV
						

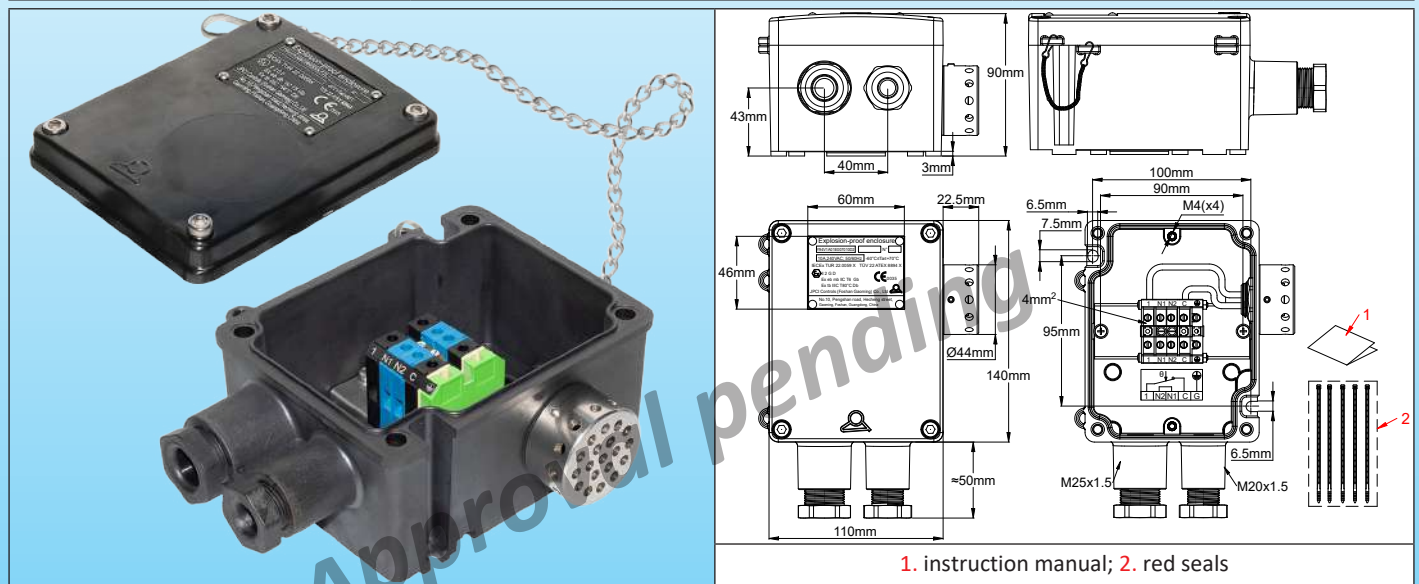

### General rules for installation:

**Important note:** These limiters are intended to monitor or control ambient temperatures in gas or dust hazardous areas.

**For gas hazardous areas,** this equipment is approved as “Ex- mb eb” and is suitable for use in zone 1 and zone 2, gas group IIC (Hydrogen/Acetylene, the highest protection group), with a temperature classification T6;

**For dust hazardous areas,** this equipment is approved as “Ex- mb”, suitable for use in, zone 21 and zone 22, the dust group is IIIC (electric conductive dust, the highest protection group), maximum allowed equipment temperature 80°C. The thermostat enclosure is approved “Ex-e”.

The applicable ambient temperature of the equipment is:  
NC: 10(8)A, 240VAC; 50/60 Hz; -60°C to +80°C (T6/T80°C)

**Housing:** Aluminum, 140 × 110 × 90mm (Dimensions without cable glands), epoxy painting, RAL7035 (thickness less than 0.2mm).

**Temperature sensing element:** Bimetal disc thermostat. Temperature sensing element is located outside the aluminum enclosure, on right side

**Electrical connection:** On built-in junction block, for conductors from 0.5mm<sup>2</sup> to 4mm<sup>2</sup>, screw terminals. 4 terminals for neutral, and line, including jumpers between input and output for neutral. There are also 2 ground terminals M4 inside and 2 outside the enclosure.

**Adjustment:** Fixed setting thermostat.

**Mounting:** Wall mounting, by 2 holes dia. 6.5mm at 100mm × 95mm distance. The housing rear side also includes four M4 threaded holes 36.5 × 75mm distance for mounting metal brackets and feet providing offset wall mounting, pole or pipes mounting (see the accessories in the last part of this catalog)

**Contacts:** SPNC open on temperature rise snap action contact.

**Electrical rating:** 10A 240V resistive (30.000 cycles) and 8A 240V inductive (6000 cycles). Suitable for power control, remote control of relay coils or PLCs circuits, and direct power switching. These devices use silver contacts or silver alloy contacts. Due to the possible oxidation of the contacts in time, we do not recommend the use of AC or DC low-voltage circuits (24V or less) if the switched intensity is less than 100mA, or the switched power less than 800mW. Contact us for those applications that require gold-plated contacts. The electrical ratings given are normalized resistive circuit values.



### Optional accessories:

- Cable glands can be fitted with special bolts for use with electrical cable protection tubes with Atex approvals.

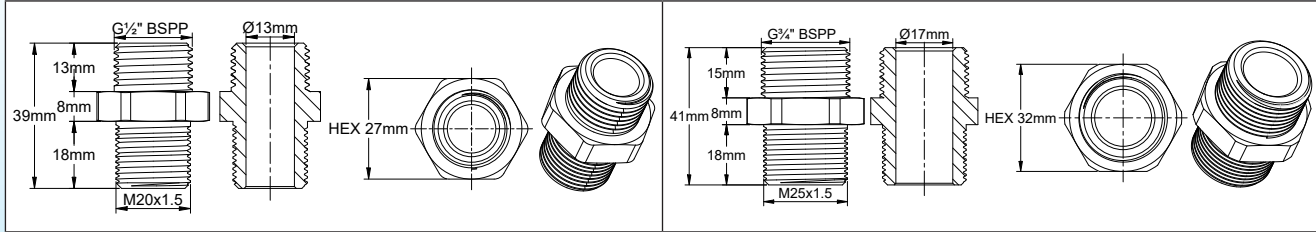

### Gas classification:

Ex II 2G Ex eb mb IIC T6 Gb

### Dust classification:

Ex II 2D Ex tb IIIC T80°C Db

### Certificates:

ATEX: TÜV 22 ATEX 8893X;

IECEX: IECEX TUR 22.0058X;

### Main part numbers

Open temperature	Close temperature	Part numbers with 2 cable glands	Part numbers with 1 cable gland
10°C±3°C, (50°F±5.4°F)	4°C±3°C, (39.2°F±5.4°F)	Y9TVB2C1E1004CC2*	Y9TVB2C1E1004CC1*
20°C ±5°C, (68°F±9°F)	10°C±5°C, (50°F±9°F)	Y9TVB2C1E2010DC2	Y9TVB2C1E2010DC1
30°C ±5°C, (86°F ±9°F)	20°C±5°C, (68°F±9°F)	Y9TVB2C1E3020DC2	Y9TVB2C1E3020DC1
40°C±5°C, (104°F ±9°F)	30°C±5°C, (86°F±9°F)	Y9TVB2C1E4030DC2	Y9TVB2C1E4030DC1
50°C±5°C, (122°F ±9°F)	40°C±5°C, (100°F±9°F)	Y9TVB2C1E5040DC2	Y9TVB2C1E5040DC1
70°C±5°C, (158°F±9°F)	60°C±5°C, (122°F±9°F)	Y9TVB2C1E7060DC2	Y9TVB2C1E7060DC1

\*: Part numbers used in antifreeze heating

Approval pending

Because of permanent improvement of our products, drawings, descriptions, features used on these data sheets are for guidance only and can be modified without prior advice



## Section 8

**Connection boxes and enclosures with built-in connection blocks, intended to be used with round standard wires or self-regulated flat heating wires. **Not available with thermostats. Wall or pipe mounting.****



Because of permanent improvement of our products, drawings, descriptions, features used on these data sheets are for guidance only and can be modified without prior advice

## Pressure screw-clamping IP67 waterproof PA66 termination caps (End seals) for closing the free end of oblong or round heating cables.

Materials	Minimum tear strength	Heating cables types	Assembly		Type
PA66, stainless steel, Silicone	>25 DaN	Oblongs or round	Locked on the cable		<b>6YTEW</b>



Before assembly on cable



After cable insertion tightening and assembly on pipe

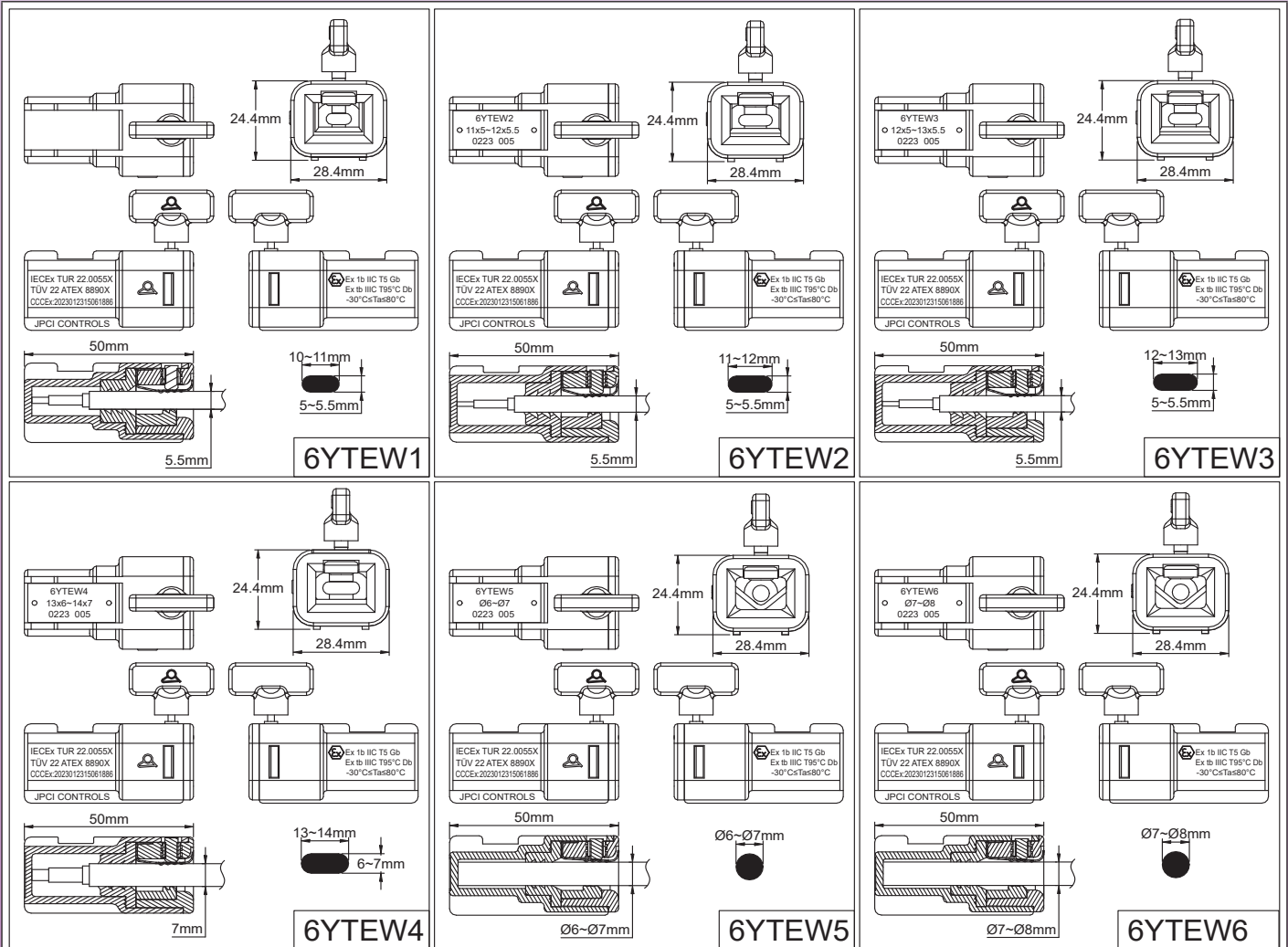

Because of permanent improvement of our products, drawings, descriptions, features used on these data sheets are for guidance only and can be modified without prior advice



## Applications

These cable ends are used to close quickly and without the need for gluing or filling with resin or the terminations of flexible self-regulating or constant power heating cables. **They are instantly tightened and blocked on the cables without special tool or equipment.**

**Their tightening on the cable is made by a butterfly screw which will break at a preset torque. Unscrewing is then impossible. Once installed, they provide an IP67 seal at the end of the cable.**

**Their range of dimensions allows them to be used on most existing heat tracing heating cables in industrial or explosive environments. Their tear resistance is guaranteed regardless of the material of the outer sheath of the heating cable (Polyolefins, PVC, fluoroelastomers, FEP a.s.o.)**

## Main features

**Body material:** UV resistant PA66. (Internal seal is in silicone).

The wings of the body allow to move it away from the piping and improve its cooling. They also allow stable clamping on the piping by a cable tie. A notch prevents the cable tie from slipping

**Maximum temperature resistance:** +80°C. (For higher temperatures, see silicone cable end boots 6YTNJ with silicone resin filling).

**Resistance at minimum temperature:** -30°C (For lower temperatures, see the silicone cable end boots 6YTNJ with silicone resin filling).

**Tear resistance:** Greater than 25 DaN for all models.

This value is equal to or greater than required by standard EN60079-0 for cable terminations in explosive environments and higher than required by standard IEC 62395-1 for heating cables in industrial environment.

**Options:** Special dimensions possible, with minimum order of 1000 pieces.

**Other models:** In some cases, especially for constant power cables with a bus wires spacing of less than 5mm, it is necessary to use the version with silicone gel filling.

**Warning:** These products cannot be used on cables with an external metallic braid not covered by an outer jacket because in this case the waterproofing cannot be achieved. Then use terminations with silicone resin filling. (See types 6YTNJ at the end of this catalogue).

**Classification for hazardous areas:**

Gas: II 2G Ex eb IIC T5 Gb

Dust: II 2D Ex tb IIIC T95°C Db

**Certificates:**

ATEX: TÜV 22 ATEX 8895X

IECEX: IECEX TUR 22.0060X

CCCEX: 2023012315061886

## Main part numbers

Part number*	Minimum cable size	Maximum cable size	Identification
6YTEW16S0F50100	10 × 5mm	11 × 5.5mm	W1
6YTEW26S0F50110	11 × 5mm	12 × 5.5mm	W2
6YTEW36S0F50120	12 × 5mm	13 × 5.5mm	W3
6YTEW46S0F60130	13 × 6mm	14 × 7mm	W4
6YTEW56S0R60000	Dia. 6mm	Dia. 7mm	W5
6YTEW66S0R70000	Dia. 7mm	Dia. 8mm	W6

\* Types with silicone gel filling: Replace S0 by SG in the reference

Because of permanent improvement of our products, drawings, descriptions, features used on these data sheets are for guidance only and can be modified without prior advice

## Heating wires stripping dimensions

(See the technical introduction for explanation of these dimensions that can be reduced in some cases)

Self-regulating cable with jacketed braid and with clearance between bus wires equal or bigger than 5mm.	Self-regulating cable with jacketed braid and distance between bus wires lower than 5mm.	Constant power cable with jacketed braid, clearance between bus wires equal or bigger than 5mm	Constant power cable with jacketed braid, clearance between bus wires lower than 5mm
<p>There must be a minimum of 10mm distance between the semiconductor core and the metal braid.</p>	<p>One conductor wire must be cut to maintain a 5mm minimum clearance between the 2 bus wires. There must be a minimum of 10mm distance between the semiconductor core and the metal braid.</p>	<p>There must be a minimum of 10mm distance between the bus wires and the metal braid. The small heating wire must not protrude from its insulating jacket</p>	<p>One conductor wire must be cut to maintain a 5mm minimum clearance between the 2 bus wires. There must be a minimum of 10mm distance between the bus wire and the metal braid. The small heating wire must be cut to not protrude from its insulating jacket. <b>It is mandatory to use the termination with silicone gel filling.</b></p>

## Installation instruction

<ul style="list-style-type: none"> <li>- Prepare the end of the cable according to the dimensions given in the table above.</li> <li>- Check that its dimensions are compatible with those written on the selected termination cap.</li> <li>- Check that the calculated or measured operating temperature does not exceed the limit value of 120°C at the termination cap.</li> </ul>			
	<ul style="list-style-type: none"> <li>- Insert the cable into the termination cap, push it strongly until it comes to a stop. (It must penetrate 48mm)</li> </ul>	<ul style="list-style-type: none"> <li>- Tighten the wing screw until it breaks flush with the termination cap.</li> <li>- This screw is calibrated to break when the torque necessary for the pulling force of the cable to comply with standards is reached. <u>The whole assembly is no longer removable.</u> (When the application requests subsequent disassembly, it is possible to replace, before installation, the wing screw with a simple M4 × 8mm grub screw, with hexagonal hollow head. The recommended tightening torque is then 1.3Nm)</li> </ul>	<ul style="list-style-type: none"> <li>- Fix the cable termination cap on the piping or on the surface, using a nylon tie or a metal clamp and placing it on the notch provided, to prevent it from slipping.</li> <li>- Tightening should be moderate so as not to damage the termination cap. If the pipe temperature can rise temperatures up to 80°C, keep the termination away of the tube</li> </ul>



## 2 ways in line connection box in PPS for heat tracing cables, with insulation piercing terminals, for self-regulating cables

2 ways in line	Insulation piercing	Wire gauge	Cables diameters		Types
		1~6mm <sup>2</sup> 32A	 8 ~ 16 8 x 5 15 x 7		<b>Y40</b>

1. Red seal; 2. Stainless steel chain

### Wall or surface mounting by the 2 holes on the enclosure

1. Red seal; 2. Stainless steel chain

### Direct pipe surface mounting with **short PPS legs** (mounting option 1)

1. Red seal; 2. Stainless steel chain

### Pipe surface mounting with short **stainless steel legs bracket**, for 10mm thermal insulation (Mounting option 2)

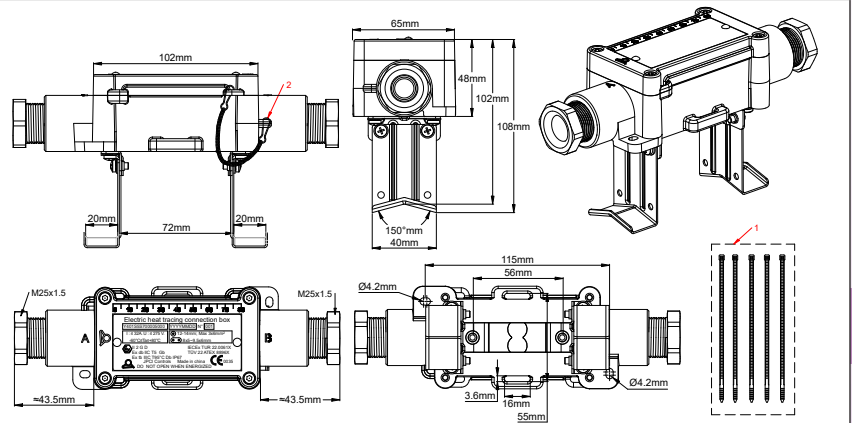

1. Red seal; 2. Stainless steel chain

Example of mounting at distance of the pipe with the **long legs** stainless steel bracket (Mounting option 5)

## Applications

This box is used to connect a **power supply cable to a self-regulating cable, or two self-regulating cables end to end.** It can be mounted flat on a surface, or on a pipe, including with insulation up to 50mm thick.

Access to connectors is very easy, and the connection is very simple, in particular for flat self-regulating cables with **metallic protective braid.**

They can be used in domestic and industrial environments as well as in explosive atmospheres.

They are particularly suited to industrial or saline environments, indoors or outdoors.

### Approvals:

- **Industrial applications in electrical heat tracing** according to IEC 62395.

- **Applications in explosive environments:** These boxes are approved as Increased safety "e": (Device preventing the production of sparks at the connections by ensuring the necessary mechanical support and insulation).

### Optional accessories:

- Cable glands can be fitted with special bolts for use with electrical cable protection tubes with Atex approvals.

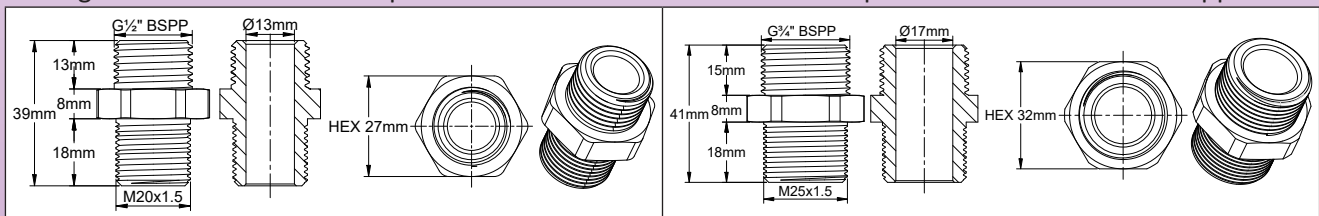

**Protection against gas:** Ex II 2G Ex cb IIC T5 Gb

**Protection against dust:** Ex II 2D Ex tb IIIC T95°C Db

**Certificates:** ATEX: TÜV 22 ATEX 8896 X; IECEx: IECEx TUR 22.0061 X; CCCEX: ??

## Main features

**Material:** Fiber glass reinforced PPS, with very high mechanical strength. Superior UV and very cold temperature resistance.

**Waterproof grade:** IP67 and IP69K (high pressure hot water washing)

**Shocks resistance:** The highest, IK10 (Cable gland not included).

### Mounting:

- **Wall mounting:** 2 wall mounting lugs allow the mounting on a flat surface. Holes distance 112 × 45mm.
- **Pipe mounting without offset:** Two removable PPS legs are supplied as standard and allow mounting on a tube using a nylon tie or metal clamp. The distance from the tube limits the heating of the box.
- **Pipe mounting with 10mm offset:** Two removable stainless steel legs are supplied as standard and allow mounting on a tube using a nylon tie or metal clamp. The distance from the tube limits the heating of the box.
- **Pipe mounting with 50mm offset:** Two removable stainless steel legs allow the installation of a thermal insulation and its protection before snapping-on the box on it and making electric connections (Available as an accessory, see catalogue page on 6YTQW parts).

### Terminals:

- The terminals are piercing the insulation layers with a multiple chisels blade and retain the contact pressure by means of an elastic blade (patented).
- **These terminals are designed to receive self-regulating heating cables with any distance between the bus wires between 2mm and 10mm.**
- These terminals can also possibly be used for conventional conductors of power supply cables.
- All terminals are protected against loosening by vibration or thermal shock.
- The mechanical tightening of the cable is ensured by a screwed metal saddle, usable on round or flat cable.

This patented saddle also ensures the earthing of the metal braid of the heating cables.

- Wire gauge:  $3 \times 1 \text{ mm}^2$  to  $3 \times 6 \text{ mm}^2$ .
- Maximum permissible intensity: 32A 250V.

**Cables outlet:** with M25 cable glands, with 50 shore silicone gaskets

**Inviolability:** The case can receive one or two seals (Supplied with 5 red nylon ties for use in the sealing holes).

**Ambient temperature limits:** -60 to +50° C. (-76°F; +122°F)

**Maximum linear power of heating cable:** 75W / m.

**Maximum intensity:** 32A per terminal.

**Easy assembly:** Assembly is made with full access to terminals when cover is removed. Mounting on wall or pipe can be made with cover removed or cover assembled closed without being hindered by the tightening link

## Available round cable gaskets

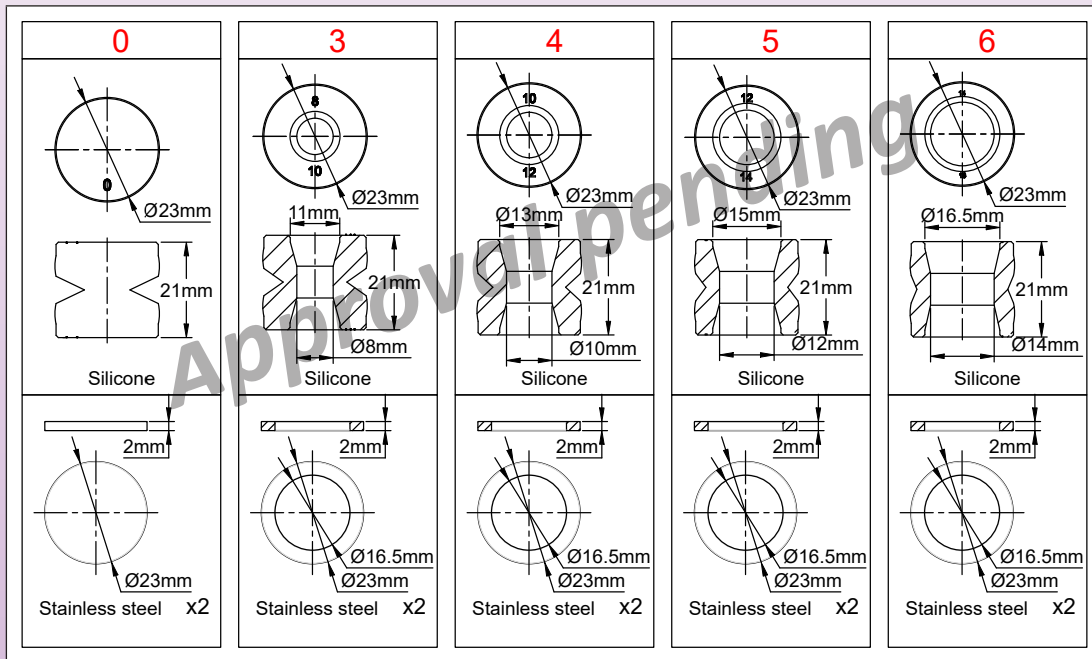

## Available flat heating cable gaskets

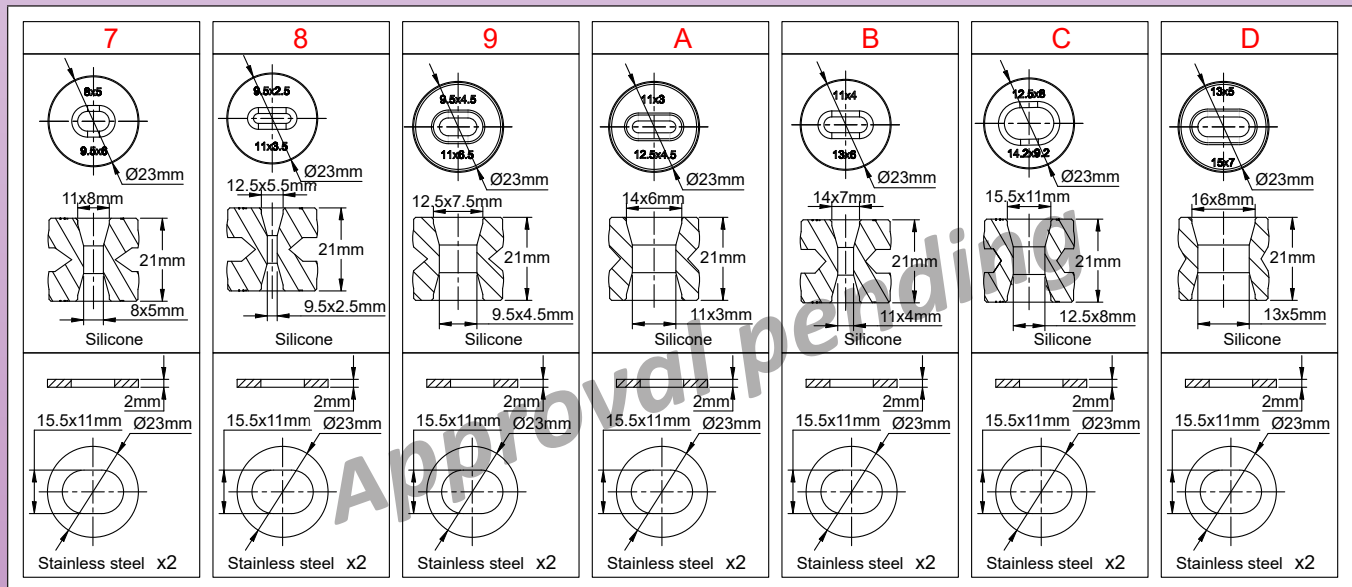

## Main references codification

Y40-\*.\*\*-\*\*\*

- \*= cable gland gasket code on A side
- \*\*= cable gland gasket code on B side
- \*\*\*= Mounting legs option

Because of permanent improvement of our products, drawings, descriptions, features used on these data sheets are for guidance only and can be modified without prior advice

## Stripping dimensions of the braided self-regulating cable, and stripping dimension of the power supply cable.

(More detailed instructions are available in the technical introduction)

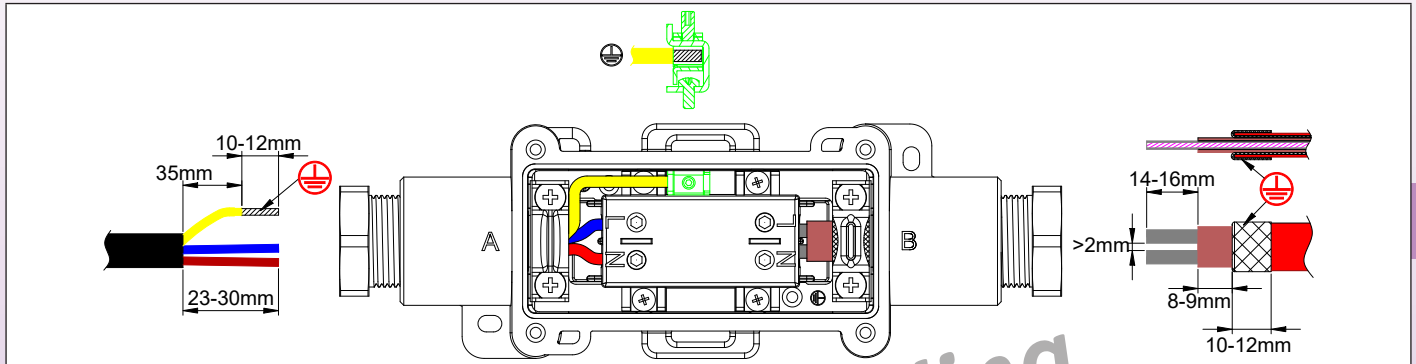

Model with one power supply cable and one heating cable

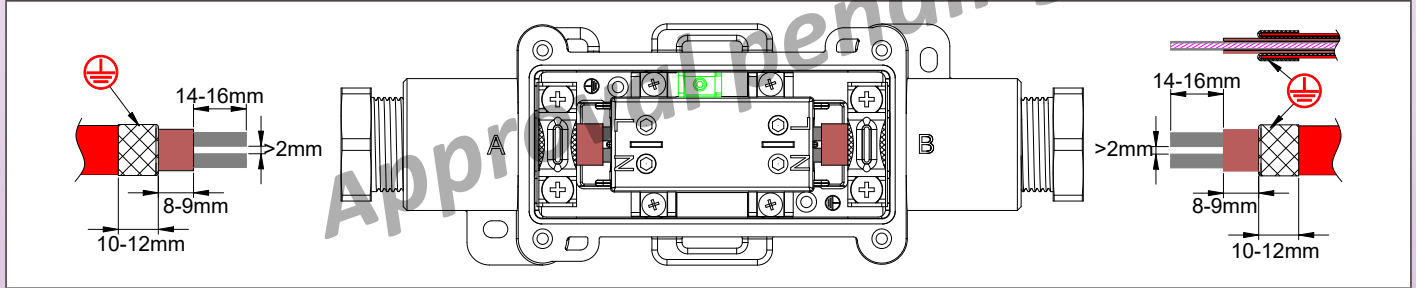



Model with two heating cable

## Self-regulating cables assembly steps

<p><b>1</b></p>	<p><b>2</b></p>
<p>1: Cut the cable, slide on it the cable gland nut. Select the cable gland gasket with the compatible hole diameter and slide it on the cable</p>	<p>2: Remove external jacket on the requested length.</p>
<p><b>3</b></p>	<p><b>4</b></p>
<p>3: Cut the braid at the requested length. Don't unweave it.</p>	<p>4: Strip heating zone insulation at the requested length.</p>

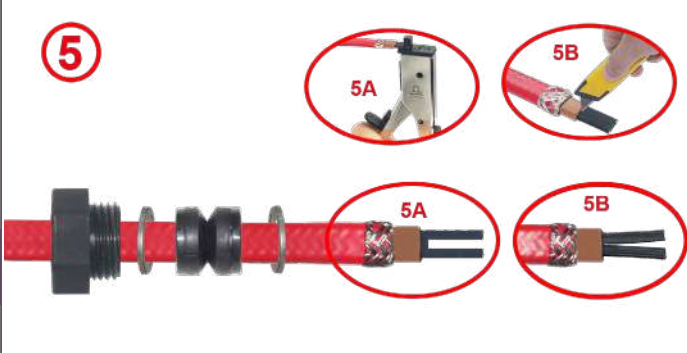
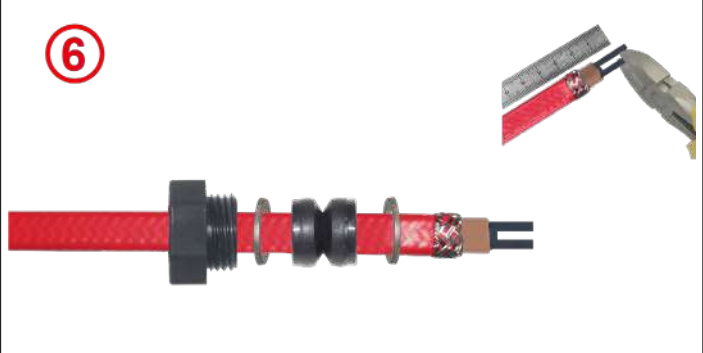
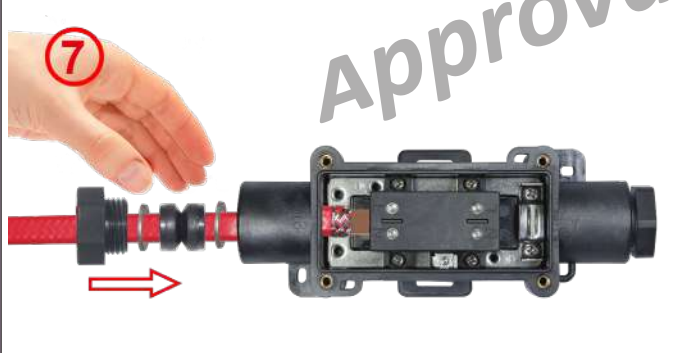
\* These exclusive tools are available in accessories section

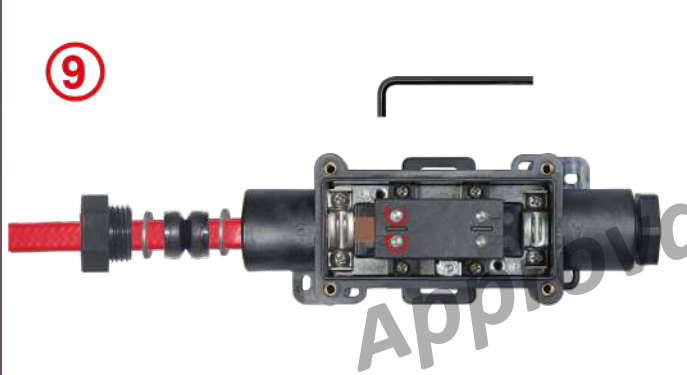
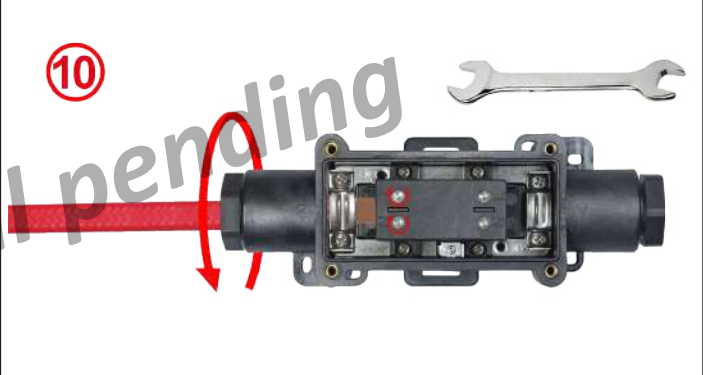
	
<p>5: Cut the heating zone between the 2 bus wires at the requested length. It can be made with a special tool (5A) or with a cutter (5B)</p>	<p>6: Adjust, if needed, the length of the bus wires.</p>
	
<p>7: Unscrew the saddle and remove it if necessary, then pass the cable through the cable gland. Slide the end of the self-regulating cable into the terminal block until it stops.</p>	<p>8: Tighten the saddle on the metal braid. Recommended tightening torque: 1.6 Nm.</p>
	
<p>9: Tighten the terminal screw until electrical contact is made with the conductor of the heating cable. Tightening torque is around 1.5 Nm. This tightening torque may vary depending on the thickness and hardness of the material of the semiconductor thermoplastic compound. If necessary, check the continuity with an ohmmeter by measuring the resistance between the two terminals N and L.</p>	<p>10: Slide the flat cable gasket into the cable gland and tighten the nut. Max. tightening torque 3N.m. If not yet made connect the other cable and close the lid.</p>

Because of permanent improvement of our products, drawings, descriptions, features used on these data sheets are for guidance only and can be modified without prior advice

## Round cable assembly steps

<p><b>1:</b> Remove outer jacket on 24mm. Then strip the conductors on 10mm. Eventually, crimp cable shoes. Slide the cable gland nut on the cable. Select the compatible diameter gasket and slide it too on the cable.</p>	<p><b>2:</b> Put the neutral and line wires inside the screw terminals and tighten them. Recommended torque 1.6 Nm.</p>
<p><b>3:</b> Slide the ground wire under the ground terminal square washer and tighten the screw. Recommended torque 1.6 Nm.</p>	<p><b>4:</b> Slide the round cable gasket into the cable gland and tighten the nut. Maximum tightening torque 3N.m.</p>

## Assembly steps on pipe of stainless steel legs for thermal insulation.

This bracket has been designed to simplify these assembly steps.

<p><b>1:</b> Take the components of the mounting plate, which has 7 parts. The snap-on support (A), the two feet (B) and the four screws (C). Screw the bracket (A) on the bottom of the selected enclosure</p>	<p><b>2:</b> Assemble the two feet with the four screws. Take the 2 legs (B) and the 4 screws (C)</p>	<p><b>3:</b> Secure the plate and its legs to the tube with metal clamps (recommended), or if necessary, nylon ties. Screw the 2 legs on the bracket A and enclosure sub-assembly</p>

Because of permanent improvement of our products, drawings, descriptions, features used on these data sheets are for guidance only and can be modified without prior advice

 <p><b>4</b></p>	 <p><b>5</b></p>	 <p><b>6</b></p>
<p><b>4:</b> Separate the box from the two feet. It will be reassembled after installation of the insulation and any metal protective sheath. Assemble on the pipe with cable ties or stainless steel hose clamp.</p>	<p><b>5:</b> Place the heating cable on the tube following the recommendations of its manufacturer. Wrap the thermal insulation around the tube, leaving the end of the cable(s) out of the insulation at least 60mm from the two tabs. You just need to make a 50mm straight cut in the insulation to let each leg pass. Unscrew the bracket and enclosure sub-assembly and remove it.</p>	<p><b>6:</b> If the thermal insulation has a metal protective sheath, make two straight incisions of 4x42mm at a distance of 52mm to allow each of the two legs to pass. Provide the orifice(s) to exit the cables from the metal protection. Equip them with M25 cable glands with the appropriate gaskets for the dimensions of the cables. Close the metal sheath around the tube. Wrap insulation on the pipe, just making two straight cuts for the legs.</p>
 <p><b>7</b></p>	 <p><b>8</b></p>	
<p><b>7:</b> Seal the clearance between the metal tabs and the outer sheath of the piping with a silicone or elastomeric sealing resin. Wrap the mechanical protection around the insulation, making two straight cuts for the legs.</p>	<p><b>8:</b> Refit the ends of the legs with the 4 screws on the box.</p>	

Because of permanent improvement of our products, drawings, descriptions, features used on these data sheets are for guidance only and can be modified without prior advice

## 4 ways in line connection box in PPS for heat tracing cables, with insulation piercing terminals, for self-regulating cables

Because of permanent improvement of our products, drawings, descriptions, features used on these data sheets are for guidance only and can be modified without prior advice

4 ways in line	Insulation piercing	Wire gauge	Cables diameters		Type
		1~6mm <sup>2</sup> 32A	 8 ~ 16 8 x 5 ~ 15 x 7		<b>Y41</b>

1. Red seal; 2. Stainless steel chain

### Wall or surface mounting by the 2 holes on the enclosure (mounting option 0)

1. Red seal; 2. Stainless steel chain

### Direct pipe surface mounting with short PPS legs (mounting option 1)

1. Red seal; 2. Stainless steel chain

### Pipe surface mounting with short stainless steel legs bracket, for 10mm thermal insulation (Mounting option 2)

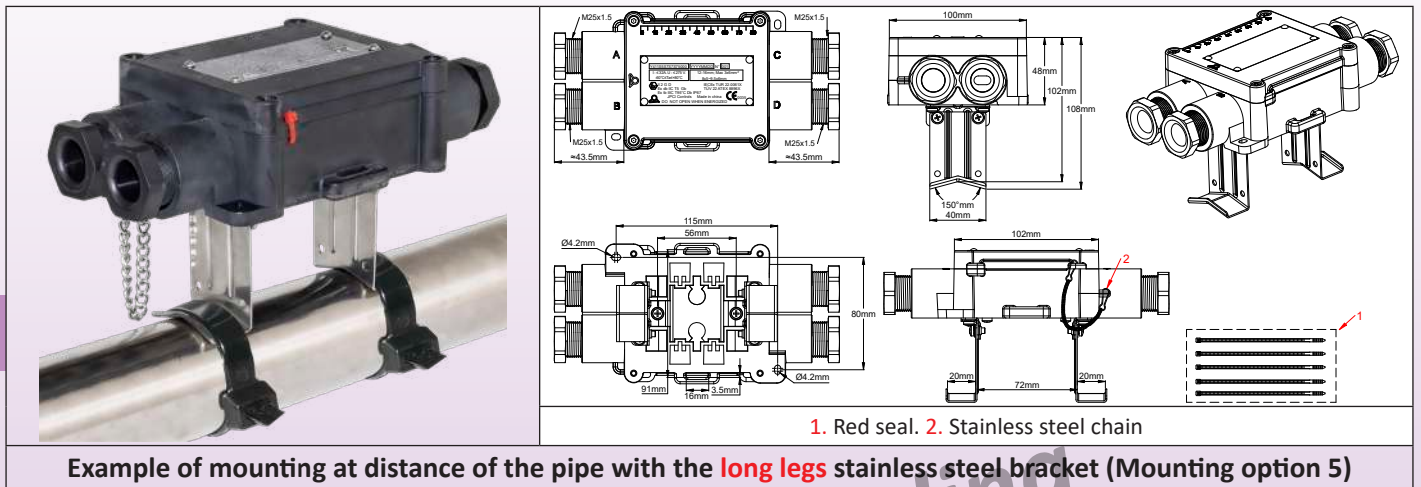

Example of mounting at distance of the pipe with the **long legs** stainless steel bracket (Mounting option 5)

## Applications

This box is used to connect a **power supply cable to 3 self-regulating cables**. It can be mounted flat on a surface, or on a pipe, including with insulation up to 50mm thick.

Pipe mounting brackets are screwed on rear side.

The terminal blocks are easily accessible and the connection is very simple, in particular for flat self-regulating cables with metallic protective braid.

They can be used in domestic and industrial environments as well as in explosive atmospheres.

They are particularly suited to industrial or saline environments, indoors or outdoors.

### Approvals:

- **Industrial applications in electrical heat tracing** according to IEC 62395.

- **Applications in explosive environments:** these boxes are approved as Increased safety "e": (Device preventing the production of sparks at the connections by ensuring the necessary mechanical support and insulation).

### Optional accessories:

- Cable glands can be fitted with special bolts for use with electrical cable protection tubes with ATEX approvals.

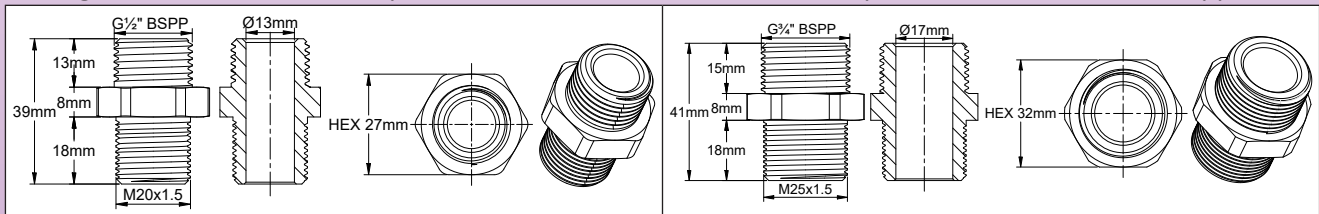

**Protection against gaz:** Ex II 2G Ex cb IIC T5 Gb

**Protection against dust:** Ex II 2D Ex tb IIIC T95°C Db

**Certificates:** ATEX: TÜV 22 ATEX 8896 X; IECEx: IECEx TUR 22.0061 X; CCCEX: ??

## Main features

**Material:** Fiber glass reinforced PPS, with very high mechanical strength. Superior UV and very cold temperature resistance.

**Waterproof grade:** IP67 and IP69K (high pressure hot water washing)

**Shocks resistance:** The highest, IK10 (Cable gland not included).

### Mounting:

- **Wall mounting:** 2 wall mounting lugs allow the mounting on a flat surface. Holes distance 112 × 45mm.

- **Pipe mounting without offset:** Two removable PPS legs are supplied as standard and allow mounting on a tube using a nylon tie or metal clamp. The distance from the tube limits the heating of the box.

- **Pipe mounting with 10mm offset:** Two removable stainless steel legs are supplied as standard and allow mounting on a tube using a nylon tie or metal clamp. The distance from the tube limits the heating of the box.

- **Pipe mounting with 50mm offset:** Two removable stainless steel legs allow the installation of a thermal insulation and its protection before snapping-on the box on it and making electric connections (Available as an accessory, see catalogue page on 6YTQW parts).

### Terminals:

- The terminals are piercing the insulation layers with a multiple chisels blade and retain the contact pressure by means of an elastic blade (patented).

- **These terminals are designed to receive self-regulating heating cables with any distance between the bus wires between 2mm and 10mm.**

- These terminals can also possibly be used for conventional conductors of power supply cables.

- All terminals are protected against loosening by vibration or thermal shock.

- The mechanical tightening of the cable is ensured by a screwed metal saddle, usable on round or flat cable.

**This patented saddle also ensures the earthing of the metal braid of the heating cables.**

- Wire gauge:  $3 \times 1 \text{ mm}^2$  to  $3 \times 6 \text{ mm}^2$ .
- Maximum permissible intensity: 32A 250V.

**Interconnection:** The neutral terminals (N) are internally connected by a jumper and so are the Line (L) terminals.

**Cables outlet:** with M25 cable glands, with 50 shore silicone gaskets.

**Inviolability:** The case can receive one or two seals (Supplied with 5 red nylon ties for use in the sealing holes).

**Ambient temperature limits:** -60 to +50° C. (-76°F; +122°F)

**Maximum linear power of heating cable:** 75W / m.

**Maximum intensity:** 32A per terminal.

**Easy assembly:** Assembly is made with full access to terminals when cover is removed. Mounting on wall or pipe can be made with cover removed or cover assembled closed without being hindered by the tightening link

## Available round cable gaskets

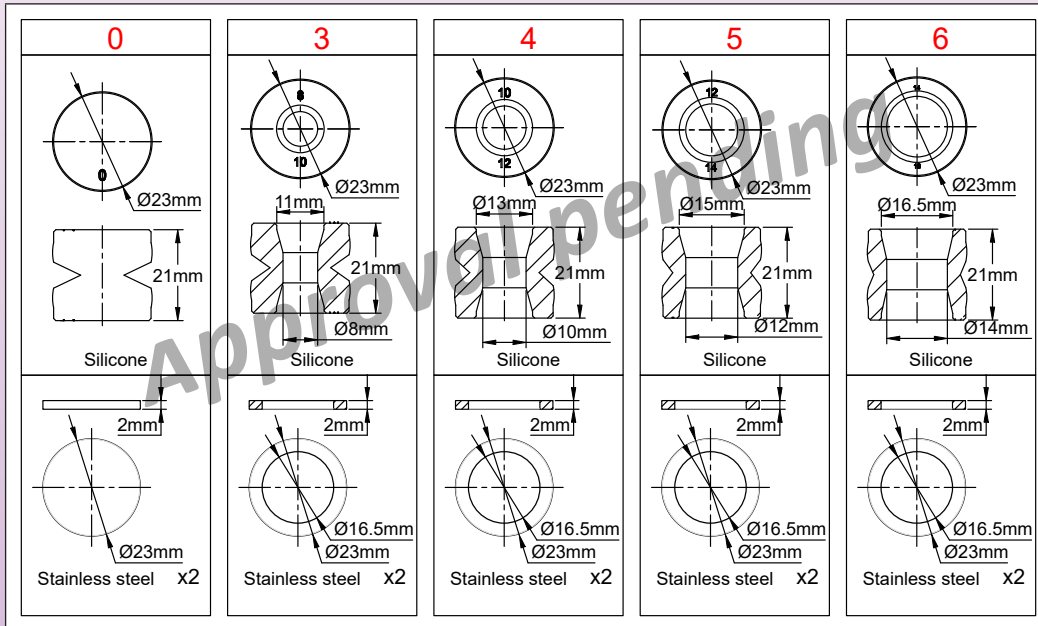

## Available flat heating cable gaskets

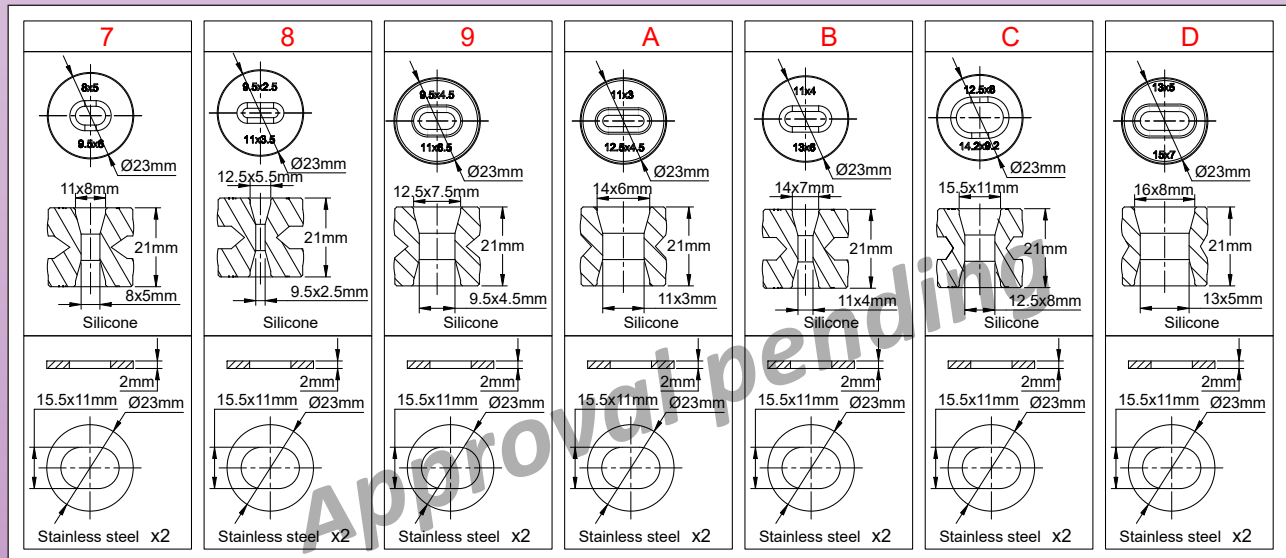

## Main references codification

Y41-\*-\*-\*-\*-\*-\*-\*

- \* = cable gland gasket code on A side
- \*\* = cable gland gasket code on B side
- \*\*\* = cable gland gasket code on C side
- \*\*\*\* = cable gland gasket code on D side
- \*\*\*\*\* = Mounting legs option

Because of permanent improvement of our products, drawings, descriptions, features used on these data sheets are for guidance only and can be modified without prior advice

## Stripping dimensions of the braided self-regulating cable, and stripping dimension of the power supply cable.

(More detailed instructions are available in the technical introduction)

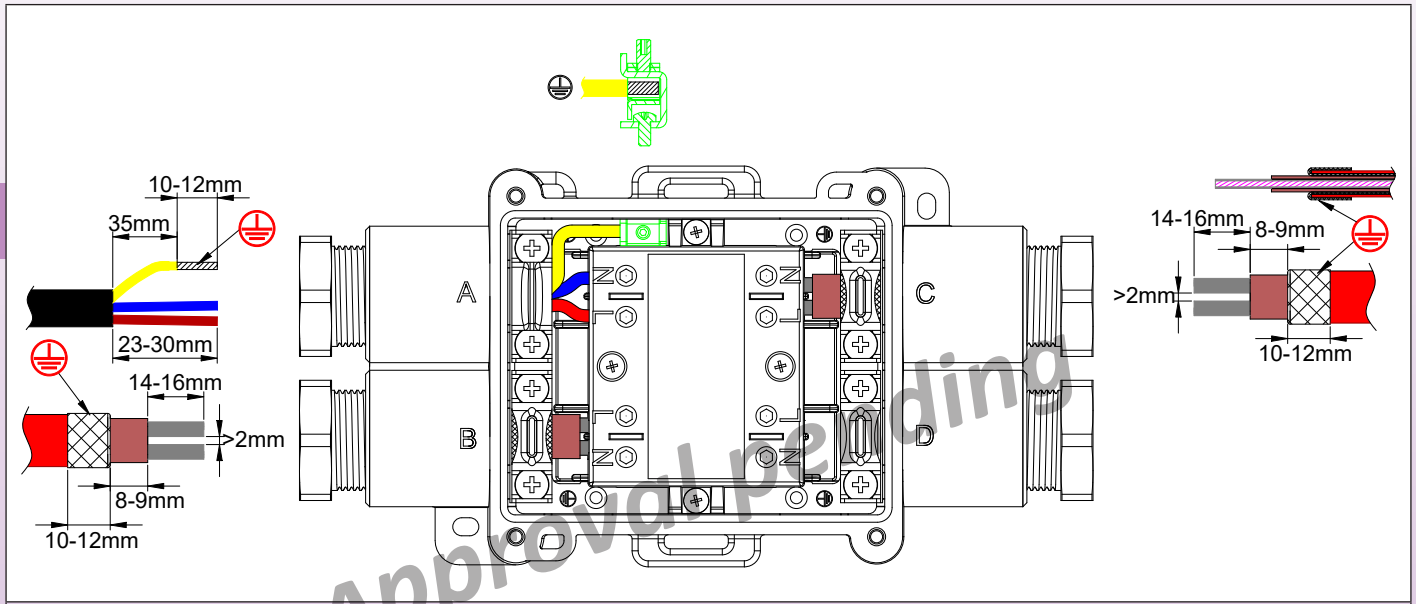

Model with 2 heating wires and one power supply cable

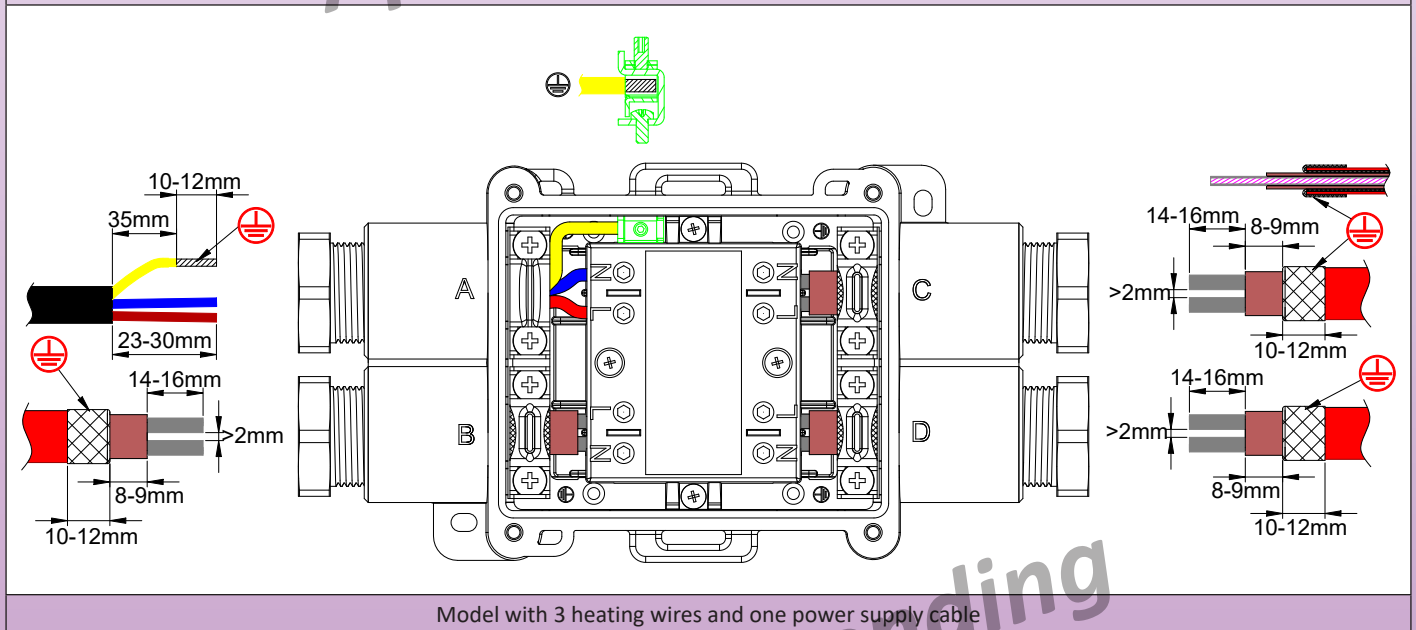

Model with 3 heating wires and one power supply cable

## Self-regulating cables assembly steps

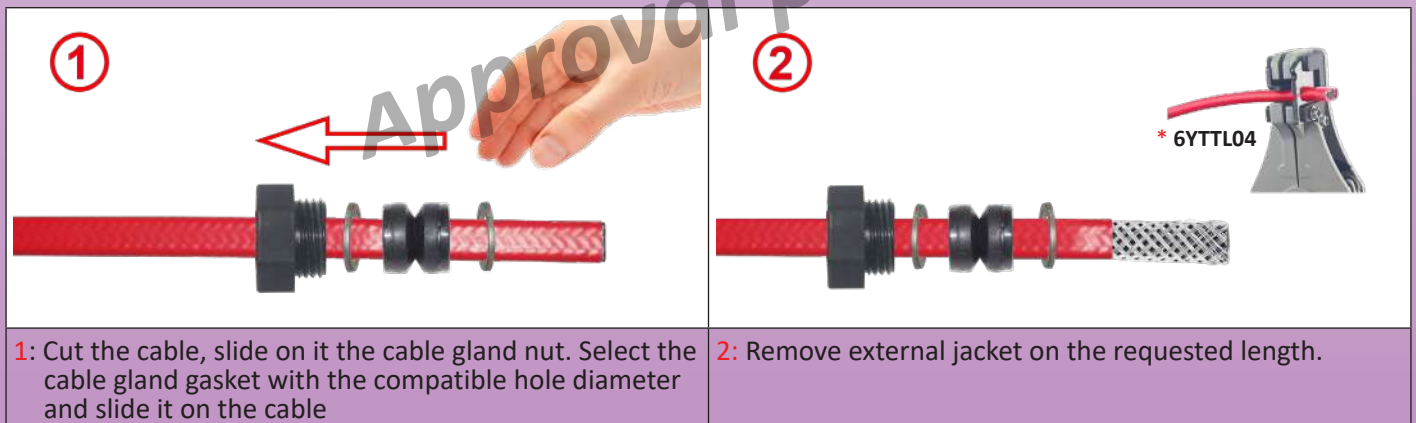

**1:** Cut the cable, slide on it the cable gland nut. Select the cable gland gasket with the compatible hole diameter and slide it on the cable







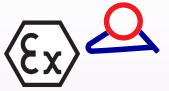

**2:** Remove external jacket on the requested length.

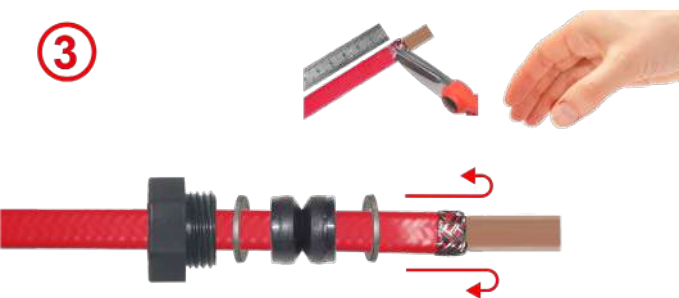
\* These exclusive tools are available in accessories section

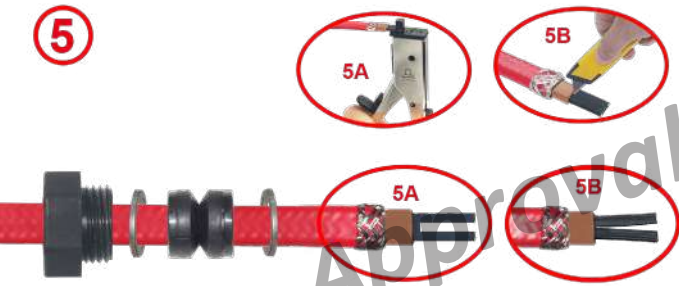
# Explosion proof connection boxes

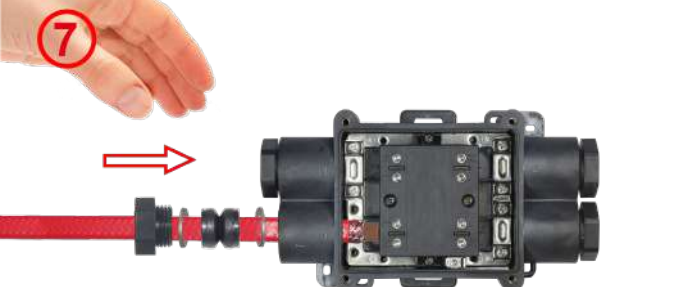

Because of permanent improvement of our products, drawings, descriptions, features used on these data sheets are for guidance only and can be modified without prior advice

 <p><b>3</b></p>	 <p><b>4</b></p> <p>* 6YTTL04</p>
<p>3: Cut the braid at the requested length. Don't unweave it.</p>	<p>4: Strip heating zone insulation at the requested length.</p>
 <p><b>5A</b> <b>5B</b></p> <p><b>5</b></p>	 <p><b>6</b></p>
<p>5: Cut the heating zone between the 2 bus wires at the requested length.</p>	<p>6: Adjust, if needed, the length of the bus wires.</p>
 <p><b>7</b></p>	 <p><b>8</b></p>
<p>7: Unscrew the saddle and remove it if necessary, then pass the cable through the cable gland. Slide the end of the self-regulating cable into the terminal block until it stops.</p>	<p>8: Tighten the saddle on the metal braid. Recommended tightening torque: 1.6 Nm.</p>
 <p><b>9</b></p>	 <p><b>10</b></p>
<p>9: Tighten the terminal screw until electrical contact is made with the conductor of the heating cable. Tightening torque is around 1.5 Nm. This tightening torque may vary depending on the thickness and hardness of the material of the semiconductor thermoplastic compound. If necessary, check the continuity with an ohmmeter by measuring the resistance between the two terminals N and L.</p>	<p>10: Slide the flat cable gasket into the cable gland and tighten the nut. Max. tightening torque 3N.m. If not yet made connect the other cable and close the lid.</p>

\* These exclusive tools are available in accessories section

## Round cable assembly steps

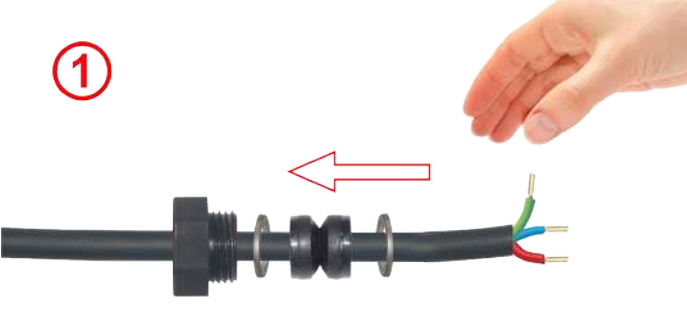
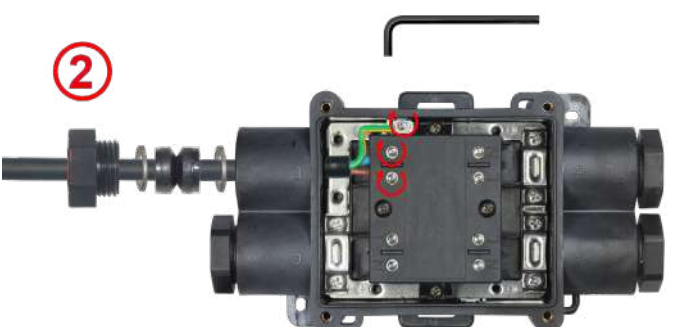
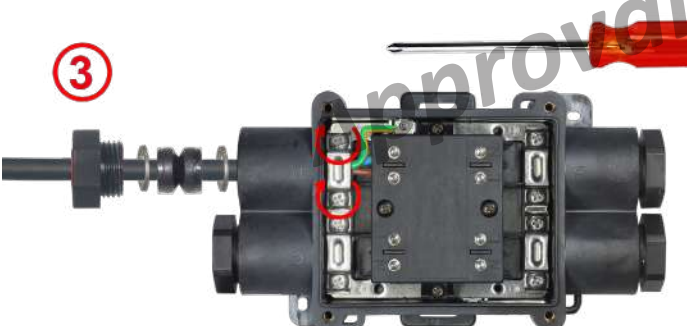
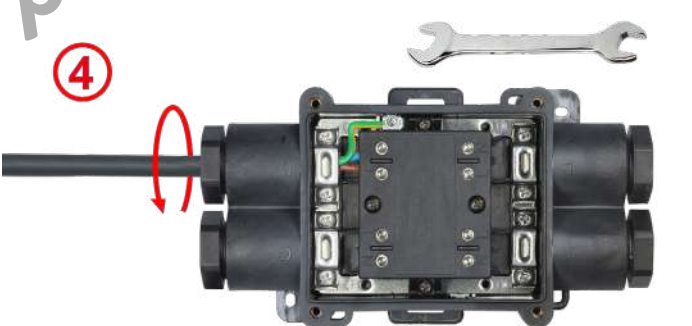
	
<p><b>1:</b> Remove outer jacket on 24mm. Then strip the conductors on 10mm. Eventually, crimp cable shoes. Slide the cable gland nut on the cable. Select the compatible diameter gasket and slide it too on the cable.</p>	<p><b>2:</b> Put the neutral and line wires inside the screw terminals and tighten them. Recommended torque 1.6 Nm.</p>
	
<p><b>3:</b> Slide the ground wire under the ground terminal square washer and tighten the screw. Recommended torque 1.6 Nm.</p>	<p><b>4:</b> Slide the round cable gasket into the cable gland and tighten the nut. Maximum tightening torque 3N.m.</p>

Because of permanent improvement of our products, drawings, descriptions, features used on these data sheets are for guidance only and can be modified without prior advice



# Section 9

## Standard accessories for enclosures and thermostats



Because of permanent improvement of our products, drawings, descriptions, features used on these data sheets are for guidance only and can be modified without prior advice

## Knobs

All explosion proof thermostat with set point adjustment type KAA, have shafts with a diameter of 6mm and a 4.6mm flat. Except in special applications, these shafts have a length of 10mm. The screwdriver adjustment shaft of models KAC has a projecting length of 1 to 2mm. The set point increases when the knob is turned clockwise.

<p>Dia. 10mm miniature arrow knob, with a slot allowing screw driver adjustment (Material: PA66)</p> <p><b>Reference</b></p> <p>66MQ006</p> <p>Compatible with printed dials 66CA01 and 66CP</p>	<p>Flat knob, dia. 41mm, height 14mm (Material: PA66)</p> <p><b>Reference</b></p> <p>66MG006*****</p> <p>Compatible with bezel 66EN1</p>	<p>Flat knob, dia. 41mm, height 12mm with soft grip touch (Material PC+ Santoprene)</p> <p><b>Reference</b></p> <p>66MZ006*****</p> <p>Compatible with bezel 66EN Standard knob used for thermostat KAA inside aluminium Ex-e enclosure</p>	<p>Flat knob, dia. 41mm, height 16.3mm, with built in adjustable stop (Material: ABS)</p> <p><b>Reference</b></p> <p>66ME006*****</p> <p>Compatible with bezel 66EN Knob used for thermostat KAA inside aluminium Ex-e enclosure when restriction to set point adjustment limits are needed</p>

## Knob printings

White color printing in °C							
-35+35°C	-10+40°C	4-40°C	0-60°C	30-90°C	30-110°C	50-200°C	50-300°C
-350353AW	-100403AW	0040403AW	0000603AW	0300903AW	0301103AW	0502003AW	0503003AW
White color printing in °F							
-30-95°F	15-105°F	40-105°F	32-140°F	85-195°F	85-230°F	120-390°F	120-570°F
-350353AX	-100403AX	0040403AX	0000603AX	0300903AX	0301103AX	0502003AX	0503003AX

\*\*\*\*\*: The complete reference is achieved by replacing the \* in red in the knob part number by the 9 characters, providing the printing and its position. The flat of the shaft is facing the temperature range high end. Other high end position on request.

Because of permanent improvement of our products, drawings, descriptions, features used on these data sheets are for guidance only and can be modified without prior advice



## Dials and bezels

The scale on the dial is in the opposite direction of the knob scale, but the set point remains clockwise increase.

<p>Square printed dial, mounting with 2 M4 screws, 28mm distance. (Material: PBT)</p> <table border="1"> <tr><th>References</th></tr> <tr><td>66CP01*****</td></tr> </table> <p>Compatible with screwdriver adjustment thermostat type KAC or on 10mm long shaft thermostat type KAA + 66MQ miniature knob</p>	References	66CP01*****	<p>Square printed dial, push in mounting inside M4 threads, 28mm distance. (Material: PBT)</p> <table border="1"> <tr><th>References</th></tr> <tr><td>66CP02*****</td></tr> </table> <p>Compatible with screwdriver adjustment thermostat type KAC or on 10mm long shaft thermostat type KAA + 66MQ miniature knob</p>	References	66CP02*****	<p>Chrome plated bezel for knobs dia. 41mm (Material: ABS)</p> <table border="1"> <tr><th>References</th></tr> <tr><td>66EN2</td></tr> </table> <p>Compatible with knobs 66MG, 66MZ, 66ME</p>	References	66EN2	<p>Black for knobs dia. 41mm (Material: ABS)</p> <table border="1"> <tr><th>References</th></tr> <tr><td>66EN1</td></tr> </table> <p>Compatible with knobs 66MG, 66MZ, 66ME</p>	References	66EN1
References											
66CP01*****											
References											
66CP02*****											
References											
66EN2											
References											
66EN1											

## Dials printings

White color printing in °C							
-35+35°C	-10+40°C	4-40°C	0-60°C	30-90°C	30-110°C	50-200°C	50-300°C
<b>-35035CAW</b>	<b>-10040CAW</b>	<b>004040CAW</b>	<b>000060CAW</b>	<b>030090CAW</b>	<b>030110CAW</b>	<b>050200CAW</b>	<b>050300CAW</b>
White color printing in °F							
-30-95°F	15-105°F	40-105°F	32-140°F	85-195°F	85-230°F	120-390°F	120-570°F
<b>-35035CAX</b>	<b>-10040CAX</b>	<b>004040CAX</b>	<b>000060CAX</b>	<b>030090CAX</b>	<b>030110CAX</b>	<b>050200CAX</b>	<b>050300CAX</b>

\*\*\*\*\*: The complete reference is achieved by replacing the \* in red in the dial part number by the 9 characters providing the printing and its position. The flat of the shaft is facing the temperature range high end. Other high end position on request. Many other knobs, dials, bezels exist. See the full list in the catalogue N°1.

Because of permanent improvement of our products, drawings, descriptions, features used on these data sheets are for guidance only and can be modified without prior advice

## Examples of assembly on thermostats

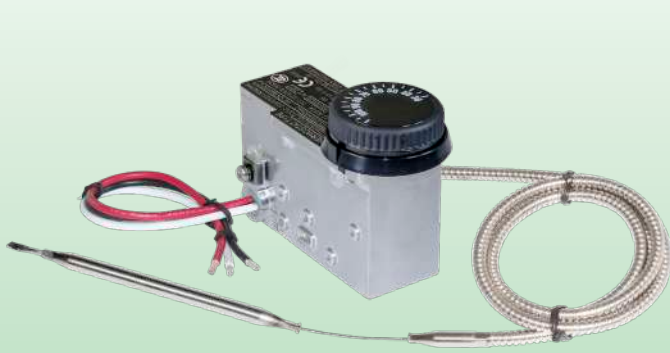

Thermostat type KAA  
with softgrip knob 66MZ and 66EN1 bezel

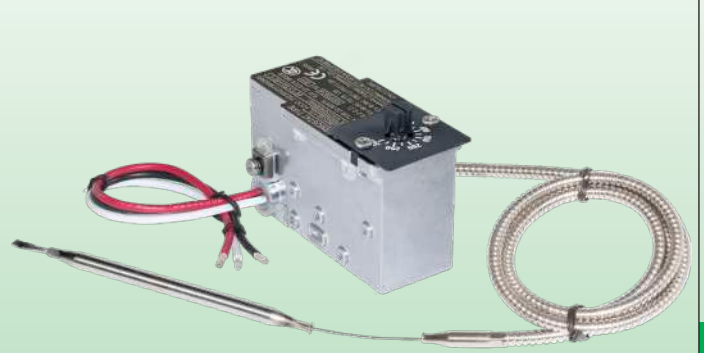

Thermostat type KAA  
with miniature knob 66MQ and 66CP02 printed dial



Thermostat type KAA  
with adjustable stop knob 66ME and 66EN1 bezel

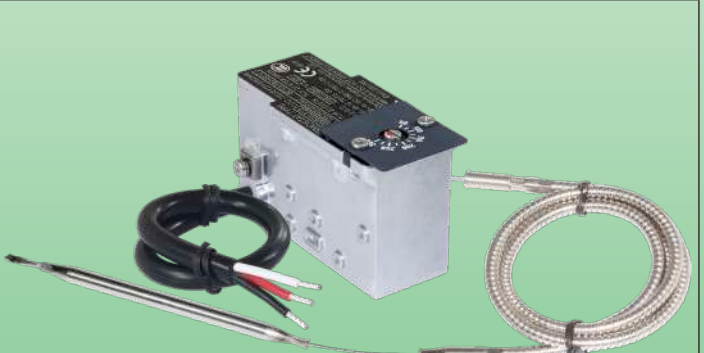

Thermostat type KAC  
with 66CP01 printed dial assembled with 2 screws M4

Because of permanent improvement of our products, drawings, descriptions, features used on these data sheets are for guidance only and can be modified without prior advice

**Stainless steel mounting feet** for aluminum or PPS explosion proof enclosures, screwed on their bottom. Mounting on pipes by nylon ties or metal clamps.

Material	Fixing	Distance to pipe	Assembly on box		Type
Stainless steel	On pipe	~50mm Or ~10mm	Screwed		<b>6YTQTW46</b> <b>6YTQTV46</b>

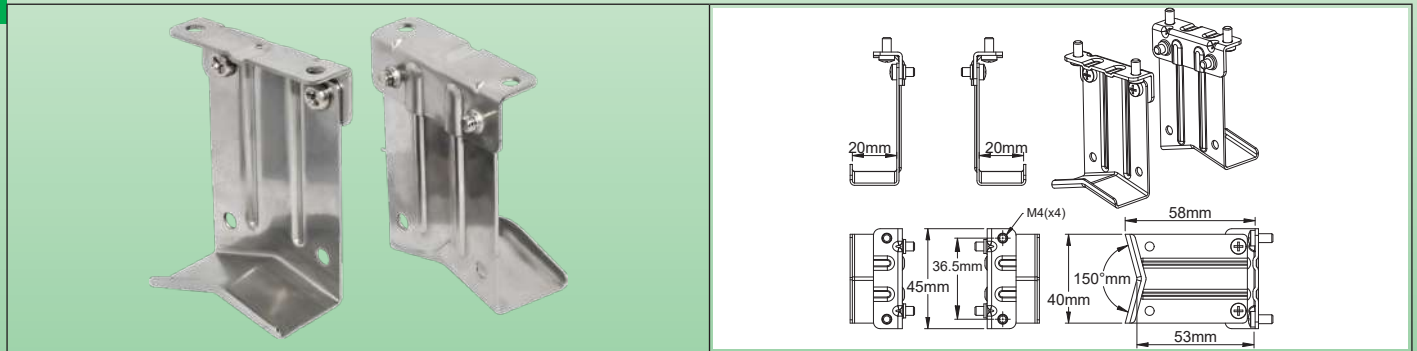

50MM

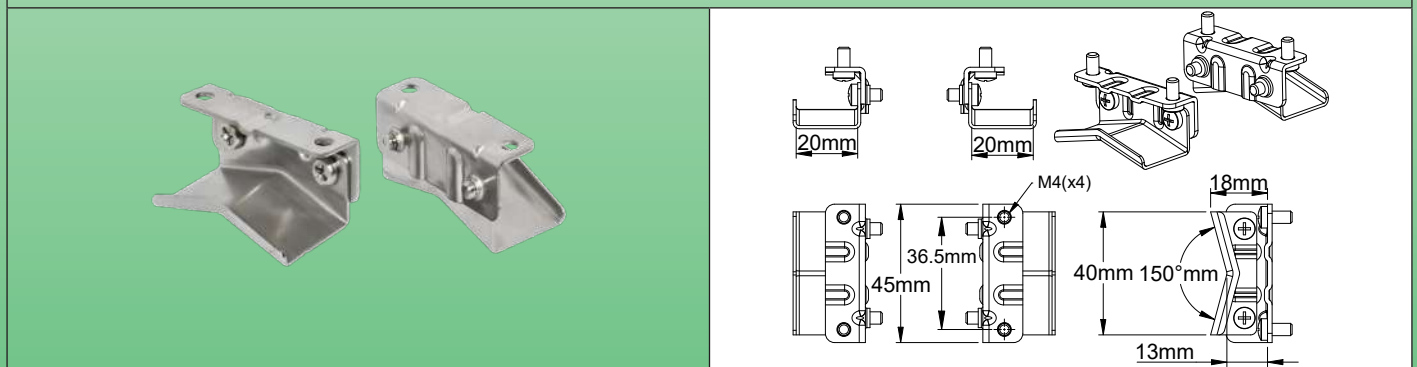

10MM



Example of assembly on 140 × 110 × 90mm enclosure (Type Y9)



Example of assembly on Y40 heat tracing connection box

Because of permanent improvement of our products, drawings, descriptions, features used on these data sheets are for guidance only and can be modified without prior advice

## Applications







These metal brackets allow to mount connection boxes for heating cables on pipes, keeping a distance of about 10 or 50mm with the pipes, which allows thermal insulation and its protection to be installed. These models allow this insulation to be carried out after the heating cables have been laid and before the boxes have been laid and connected.

The removable legs, fixed by 2 screws on the side of the bracket body can be mounted on the pipe before the thermal insulation, then requesting only two straight cut on it before to screw the legs on the bracket body. The use of stainless-steel limits thermal conduction by the feet from the pipe to the box.

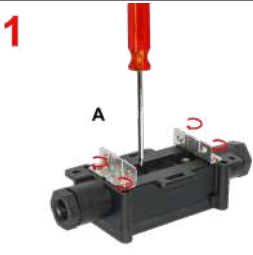
## Part numbers

Distance to pipe	Material	Part number	Can be used on:
~10mm	SUS304	6YTQW46	Y40, Y41, Y50, Y51, YB0, YB1, Y9
~50mm	SUS304	6YTQTV46	Y40, Y41, Y50, Y51, YB0, YB1, Y9

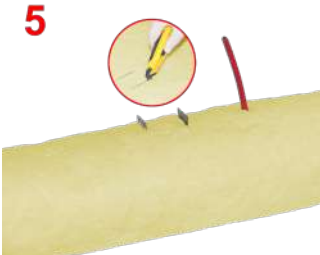
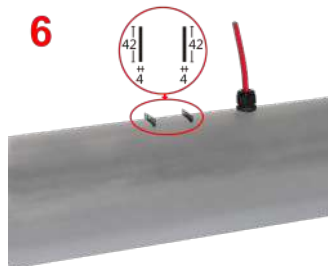
## How to install these pipe mounting legs on thermally insulated pipe

 <p><b>1</b></p>	 <p><b>2</b></p>	 <p><b>3</b></p>
<p><b>1:</b> Take the components of the mounting plate, which has 7 parts. The snap-on support (A), the two feet (B) and the four screws (C). Screw the bracket (A) on the bottom of the selected enclosure</p>	<p><b>2:</b> Assemble the two feet with the four screws. Take the 2 legs (B) and the 4 screws (C)</p>	<p><b>3:</b> Secure the plate and its legs to the tube with metal clamps (recommended), or if necessary, nylon ties. Screw the 2 legs on the bracket A and enclosure sub-assembly</p>
 <p><b>4</b></p>	 <p><b>5</b></p>	 <p><b>6</b></p>
<p><b>4:</b> Separate the box from the two feet. It will be reassembled after installation of the insulation and any metal protective sheath. Assemble on the pipe with cable ties or stainless steel hose clamp</p>	<p><b>5:</b> Place the heating cable on the tube following the recommendations of its manufacturer. Wrap the thermal insulation around the tube, leaving the end of the cable (s) out of the insulation at least 60mm from the two tabs. You just need to make a 50mm straight cut in the insulation to let each leg pass. Unscrew the bracket and enclosure sub-assembly and remove it</p>	<p><b>6:</b> If the thermal insulation has a metal protective sheath, make two straight incisions of 4x42mm at a distance of 52mm to allow each of the two legs to pass. Provide the orifice(s) to exit the cables from the metal protection. Equip them with M25 cable glands with the appropriate gaskets for the dimensions of the cables. Close the metal sheath around the tube. Wrap insulation on the pipe, just making two straight cuts for the legs</p>
 <p><b>7</b></p>	 <p><b>8</b></p>	
<p><b>7:</b> Seal the clearance between the metal tabs and the outer sheath of the piping with a silicone or elastomeric sealing resin. Wrap the mechanical protection around the insulation, making two straight cuts for the legs</p>	<p><b>8:</b> Refit the ends of the legs with the 4 screws on the box.</p>	

Because of permanent improvement of our products, drawings, descriptions, features used on these data sheets are for guidance only and can be modified without prior advice

## Stainless steel mounting foot for explosion proof heat tracing cable termination. Mounting on pipes by nylon ties or metal clamps.

Material	Fixing	Distance to pipe	Assembly on box		Type
Stainless steel	On pipe	~50mm	Screwed		<b>6YTQTV47</b>

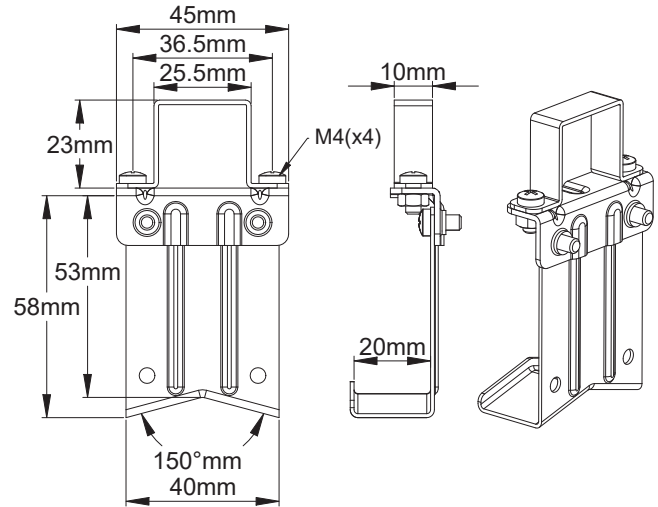

Example of assembly on heat tracing cable termination 6YTEW

### Applications

This metal bracket allows to mount heat tracing heating cable termination on pipes, keeping a distance of about 50mm with the pipes, which allows thermal insulation and its protection to be installed and avoid to reach Ex prohibited ambient temperature on the termination, e.a. when the pipe surface temperature is too high. The use of stainless-steel limits thermal conduction by the feet from the pipe to the box.

### Part numbers

Material	Part number	Can be used on:
SUS304	6YTQTV47	6YTEW
SUS316	6YTQTV67	6YTEW

Because of permanent improvement of our products, drawings, descriptions, features used on these data sheets are for guidance only and can be modified without prior advice

**PA66 or PPS mounting feet** for aluminum or PPS explosion proof enclosures, screwed on their bottom. Mounting on pipes by nylon ties or metal clamps.

Material	Fixing	Distance to pipe	Assembly on box		Type
PA66	On pipe	~10mm	Screwed		<b>6YTQPV46</b>

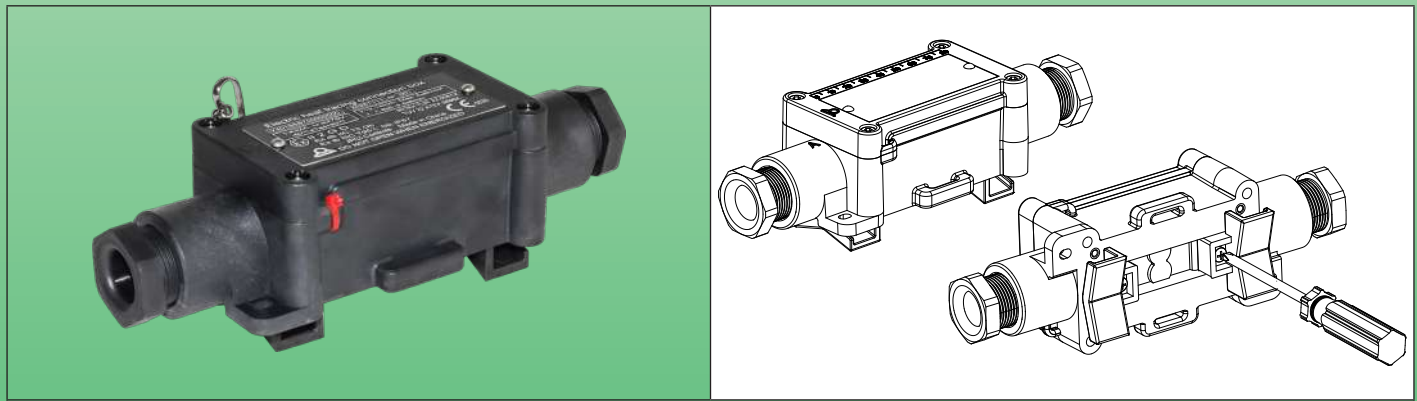
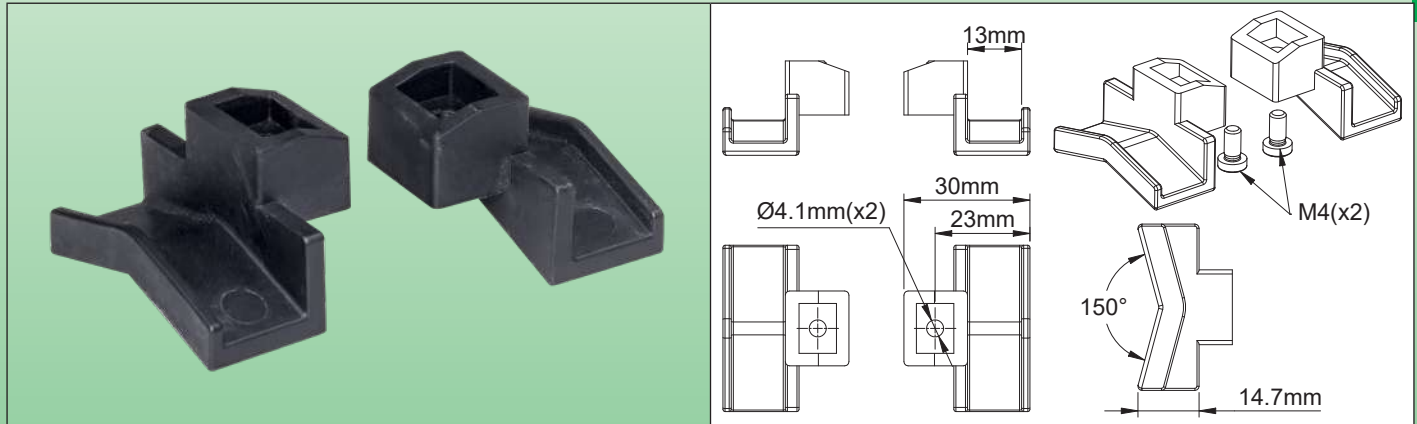

Example of assembly on Y40 heat tracing connection box

**Applications**

These economical plastic feet allow heating cable connection boxes to be mounted on pipes, while maintaining a space of approximately 10mm with the pipes, which allows solid mounting of the box on the pipes, while leaving sufficient passage for heating cables. These feet are not recommended for mounting on hot walls above 100°C. They are delivered with their two fixing screws

**Part numbers**

Part number	Can be used on:
6YTQPV46	Y40, Y41, Y50, Y51, YB0, YB1

## 4mm<sup>2</sup> live and neutral terminals PA66 connection blocks

Approval	Wires min and max cross section	Voltage	Rating	Number of connections	Continuous operating temp.	Types	
ATEX IECEX	4mm <sup>2</sup>	500 V	32 A	2	-60+110°C	<b>BW040</b>	
Connection block body (Available in black or blue)		Connection block side partition (Available in black or blue)		Connection block body		Connection block side partition	

### Main applications

These terminal blocks have been developed to allow the electrical connection of KA series explosion-proof thermostats with wired output in EX “e” increased security boxes. They allow quick mounting directly on the body of the thermostat, without the need for a DIN rail for fixing, and their footprint is reduced. They are approved for this application. Their assembly can also be done directly by screwing onto a mounting board. They are intended for the connection of copper conductors inside enclosures.

### Technical features

**Dimensions:** 40 × 41 × 6.8mm (40 × 41 × 8mm with side flange added)

**Material:** PA66, UL94VO, GWFI 960°

**Colors available:** blue or black

**Rated cross section:** 4mm<sup>2</sup> (EN 60079-7) Solid core, stranded, finely stranded, or with wire-end ferrules

**Minimum cross section:** 0.5mm<sup>2</sup> (EN 60079-7) Solid core, stranded, finely stranded, or with wire-end ferrules

**Maximum voltage:** 500 V (ATEX, IECEX); 600V (IEC60947-7)

**Maximum current:** 32 A (ATEX, IECEX); 41A (IEC60947-7)

**Environment pollution level:** level 3

**Ambient temperature limits:**

Under normal operating conditions the temperature rise of the terminal blocks is max 40 K, (Measured with 110% of the maximum rated current as requested by standard). Due to the above mentioned the terminal blocks may be used in apparatus of temperature classes T6...T1 as long as the terminal block ambient temperature range is not exceeded as shown below. No part of terminal block must exceed 110°C under any condition.

T6 (- 60°C ≤ Tamb ≤ +40°C)

T5 (- 60°C ≤ Tamb ≤ +55°C)

T4 (- 60°C ≤ Tamb ≤ +70°C)

**Installation:**

- Can be mounted directly on the body of KA thermostats using two M3 screws, without requiring a 35mm DIN rail, the mounting is identical for the 4mm<sup>2</sup> and 6mm<sup>2</sup> models which can be installed side by side.
- Can be mounted directly on a board by drilling a 4mm hole for M4 screw, with a square nut in the PA66 base
- **ROHS and Reach compliants**

**Accessories:**

- Shunts allowing the electrical connection of terminal blocks of the same section side by side without using wire connection terminals.
- 3 × 7mm rail allowing the terminal blocks to be joined together when a long assembly length is mounted on the body of the thermostat
- Snap-on partition for closing at the end of a row or as a separation between blocks of different polarity

**Approvals:** IEC Ex certificate of conformity (ATEX for joint use with KA thermostats already ATEX/IECEX approved)

**Marking:** Ex eb II C Gb (EN 60079-7). II 2 G D (European standard Ex 2014/34/EU)

**Earth connection block:** see specific page.

## Main parts numbers

Live terminal without partition, black color	Live terminal with partition, black color	Neutral terminal without partition, blue color	Neutral terminal with partition, blue color	Partition alone, black color	Partition alone, blue color
BW040BSTL	BW040FSTL	BW040BSTN	BW040FSTN	BW040C00L	BW040C00N

## Accessories

Anodized aluminum labels, they can be easily cut to requested length, depending of number of connection blocks side by side	Set of screws for direct assembly of connection blocks on KA thermostat or for assembly side by side.	Brass rod for mounting inside Y92KA heat tracing box of very long assembled blocks	Terminal jumpers for interconnection, side by side, of 2 blocks of same potential
66BW040AL53	66BW040(A, B, C, D, E, F)	66BWBR75	66BW040S13

Because of permanent improvement of our products, drawings, descriptions, features used on these data sheets are for guidance only and can be modified without prior advice

## 6mm<sup>2</sup> live and neutral terminals PA66 connection blocks

Approval	Wires min and max cross section	Voltage	Rating	Number of connections	Continuous operating temp.	Types
ATEX IECEX	6mm <sup>2</sup>	500 V	41 A	2	-60+110°C	<b>BW060</b>
Connection block body (Available in black or blue)		Connection block side partition (Available in black or blue)		Connection block body		Connection block side partition

### Main applications

These terminal blocks have been developed to allow the electrical connection of KA series explosion-proof thermostats with wired output in EX "e" increased security boxes. They allow quick mounting directly on the body of the thermostat, without the need for a DIN rail for fixing, and their footprint is reduced. They are approved for this application. Their assembly can also be done directly by screwing onto a mounting board. They are intended for the connection of copper conductors inside enclosures.

### Technical features

**Dimensions:** 46 × 41 × 8.4mm (46 × 41 × 9.6mm with side flange added)

**Material:** PA66, UL94VO, GWFI 960°

**Colors available:** Blue or black

**Rated cross section:** 6mm<sup>2</sup> (EN 60079-7) Solid core, stranded, finely stranded, or with wire-end ferrules

**Minimum cross section:** 0.5mm<sup>2</sup> (EN 60079-7) Solid core, stranded, finely stranded, or with wire-end ferrules

**Maximum voltage:** 500 V (ATEX, IECEX); 600V (IEC60947-7)

**Maximum current:** 41 A (ATEX, IECEX); 41A (IEC60947-7)

**Environment pollution level:** level 3

**Ambient temperature limits:**

Under normal operating conditions the temperature rise of the terminal blocks is max 40 K, (Measured with 110% of the maximum rated current as requested by standard). Due to the above mentioned the terminal blocks may be used in apparatus of temperature classes T6...T1 as long as the terminal block ambient temperature range is not exceeded as shown below. No part of terminal block must exceed 110 °C under any condition.

T6 (- 60°C ≤ Tamb ≤ +40 °C)

T5 (- 60°C ≤ Tamb ≤ +55 °C)

T4 (- 60°C ≤ Tamb ≤ +70 °C)

**Installation:**

- Can be mounted directly on the body of KA thermostats using two M3 screws, without requiring a 35mm DIN rail, the mounting is identical for the 4mm<sup>2</sup> and 6mm<sup>2</sup> models which can be installed side by side.
- Can be mounted directly on a board by drilling a 4mm hole for M4 screw, with a square nut in the PA66 base
- **ROHS and Reach compliants**

**Accessories:**

- Shunts allowing the electrical connection of terminal blocks of the same section side by side without using wire connection terminals.
- 3×7mm rail allowing the terminal blocks to be joined together when a long assembly length is mounted on the body of the thermostat
- Snap-on partition for closing at the end of a row or as a separation between blocks of different polarity

**Approvals:** IEC Ex certificate of conformity (ATEX for joint use with KA thermostats already ATEX/IECEX approved)

**Marking:** Ex eb II C Gb (EN 60079-7). II 2 G D (European standard Ex 2014/34/EU)

**Earth connection block:** See specific page.

## Main parts numbers

Live terminal without partition, black color	Live terminal with partition, black color	Neutral terminal without partition, blue color	Neutral terminal with partition, blue color	Partition alone, black color	Partition alone, blue color
BW060BSTL	BW060FSTL	BW060BSTN	BW060FSTN	BW060C00L	BW060C00N

## Accessories

Anodized aluminum labels, they can be easily cut to requested length, depending of number of connection blocks side by side	Set of screws for direct assembly of connection blocks on KA thermostat or for assembly side by side.	Brass rod for mounting inside Y92KA heat tracing box of very long assembled blocks	Terminal jumpers for interconnection, side by side, of 2 blocks of same potential
66BW060AL62	66BW060(A, B, C, D, E, F)	66BWBR75	66BW060S15

Because of permanent improvement of our products, drawings, descriptions, features used on these data sheets are for guidance only and can be modified without prior advice

## 4mm<sup>2</sup> and 6mm<sup>2</sup> ground terminal connection blocks in aluminum

Approval	Wires min and max cross section	Voltage	Rating	Number of connections	Continuous operating temp.	Types
ATEX IECEX	4mm <sup>2</sup> (6mm <sup>2</sup> )	500 V	32 A (41A)	2	-60+110°C	<b>BX040 (BX060)</b>

### 4mm<sup>2</sup> models

Aluminum connection block body	Connection block side partition in PA66	Connection block body	Connection block side partition

### 6mm<sup>2</sup> models

Aluminum connection block body	Connection block side partition in PA66	Connection block body	Connection block side partition

## Main applications

These terminal blocks have been developed to allow **to add ground electrical connection** on KA series explosion-proof thermostats with wired output in EX "e" increased security boxes. They allow quick mounting directly on the body of the thermostat, without the need for a DIN rail for fixing, and their footprint is reduced. They are approved for this application. Their assembly can also be done directly by screwing onto a mounting board. They are intended for the connection of copper conductors inside enclosures.

## Technical features

### Dimensions:

- 4mm<sup>2</sup>: 40 × 41 × 6.8mm (40 × 41 × 8mm with partition side flange added)
- 6mm<sup>2</sup>: 46 × 41 × 8.4mm (46 × 41 × 9.6mm with partition side flange added)

**Material:** Aluminum with green epoxy painting. Yellow green combination used for ground terminals is achieved by using a yellow partition in PA66.

**Colors available:** Green for aluminum body, yellow for partition in PA66

**Rated section:** 4mm<sup>2</sup> or 6mm<sup>2</sup> (EN 60079-7) Solid core, stranded, finely stranded, or with wire-end ferrules

**Minimum cross section:** 0.5mm<sup>2</sup> (EN 60079-7) for solid core, stranded, finely stranded, or with wire-end ferrules

### Ambient temperature limits:

Under normal operating conditions the temperature rise of the terminal blocks is none. Due to the above mentioned the terminal blocks may be used on or in apparatus of temperature classes T6 to T1

### Installation:

- The yellow partition in PA66 is mandatory when this connection block is assembled beside a neutral or a live connection block.
- Designed to be mounted directly on the body of KA thermostats using two M3 screws, and a center M4 screw connection the terminal to the thermostat grounded body, without requiring a 35mm DIN rail, the mounting is identical for the 4mm<sup>2</sup> and 6mm<sup>2</sup>
- Can be mounted directly on a board by drilling a 4mm hole for M4 screw, with a square nut in the aluminum base
- **ROHS and Reach compliant**

### Accessories:

- Shunts allowing the electrical connection of terminal blocks of the same section side by side without using wire connection terminals.
- 3×7mm rail allowing the terminal blocks to be joined together when a long assembly length is mounted on the body of the thermostat.

Because of permanent improvement of our products, drawings, descriptions, features used on these data sheets are for guidance only and can be modified without prior advice

## Main parts numbers in 4mm<sup>2</sup>

Ground terminal <b>without partition</b> , green color	Green color ground terminal <b>with yellow PA66 partition</b>	Partition in PA66 alone, yellow color
BX040FSTG	BX040FSTM	BX040C00Y

## Main parts numbers in 6mm<sup>2</sup>

Ground terminal <b>without partition</b> , green color	Green color ground terminal <b>with yellow PA66 partition</b>	Partition in PA66 alone, yellow color
BX060FSTG	BX060FSTM	BX060C00Y

## Examples of assemblies of connection blocks BW and BX

<p>Assembly on KA thermostat of one additional BX ground connector (Without need of wiring between the thermostat ground terminal and connection block)</p>		<ul style="list-style-type: none"> <li>1: M3 assembly screws (x2);</li> <li>2: Partition for ground terminal;</li> <li>3: Terminal body;</li> <li>4: M4 screw for assembling the earth terminal block;</li> <li>5: M3 threads (x2) on KA body;</li> <li>6: M4 thread for ground terminal screw</li> </ul>
<p>Assembly screwed on any flat board (metal or plastic)</p>		<ul style="list-style-type: none"> <li>1: M4 screw;</li> <li>2: M4 Nut;</li> <li>3: M3 assembly screw (x2);</li> <li>4: Partition;</li> <li>5: Identification labels;</li> <li>6: M3 assembly nuts (x2);</li> <li>7: Mounting board;</li> </ul> <p><b>Note:</b> When assembled with M3 screws into a multiple connection blocks module, only two M4 screws and two M4 nuts are needed (1 and 2), one at each end.</p>
<p>Assembly as independant connection blocks</p>		<ul style="list-style-type: none"> <li>1: M3 assembly screw (x2);</li> <li>2: M3 assembly nuts (x2);</li> <li>3: Identification labels</li> <li>4: Partition.</li> </ul>
<p>Assembly on KA thermostat of additional ground and live connection blocks</p>		<ul style="list-style-type: none"> <li>1: M3 assembly screws (x2);</li> <li>2: Brass rod (option);</li> <li>3: Aluminum label;</li> <li>4: Partition for live terminals;</li> <li>5: Partition for ground terminal;</li> <li>6: M3 threads (x2) on KA body;</li> <li>7: M4 screw for assembly of ground terminal on thermostat body</li> <li>8: Rectangular hole for brass rod inside KA body;</li> <li>9: M4 thread for assembling the earth terminal block.</li> <li>10: Shunt (Optional);</li> </ul> <p><b>Note:</b> The brass rod can be added inside the rectangular hole of 7x2.3mm to help holding a long assembly of terminal blocks inside Y92 PPS pipe mounting heat tracing box.</p>



Because of permanent improvement of our products, drawings, descriptions, features used on these data sheets are for guidance only and can be modified without prior advice



Because of permanent improvement of our products, drawings, descriptions, features used on these data sheets are for guidance only and can be modified without prior advice

# Section 10

## Special tools







## Special tools

- Preparing the ends of heating cables and in particular cables with metallic braid and self-regulating cables can be tedious and often unfortunate and expensive. We have developed a range of hand tools to save time and achieve a professional and safe result.
- These tools are made in our factory, generally from mechanical bodies existing on the market.

# Hexagonal crimping plier for **small size wires**.

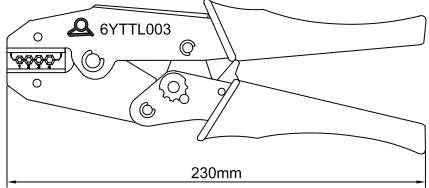

Because of permanent improvement of our products, drawings, descriptions, features used on these data sheets are for guidance only and can be modified without prior advice

Use	Wire gauge		Type
Workshop or field	0.5mm <sup>2</sup> ~2.5mm <sup>2</sup> (AWG22~AWG14)		<b>6YTTL03</b>
			
			
Case		Crimping example on 1mm <sup>2</sup> wires	

## Applications

Manual pliers with hexagonal crimping for tubular butt connectors. These pliers are used to connect a heating cable end to end to a power cable or two heating cables together. It allows quick and economical connection of conductors of equal or different dimensions.

**The dimensions of the jaws have been specially studied for applications in heating cables on small diameter conductors.**

## Main features

- Allows crimping of non-insulated butt connectors according to DIN.
- Constant crimp size thanks to the ratchet system.
- The force is amplified thanks to the reduction mechanism.
- Easy cable exit thanks to the ratchet unlocking system
- Low weight (500 grs).
- Compatible butt connectors: Diameter 3.3 and 3.9 according to DIN 46267 Part 1
- Shipped inside a professional case, with 2 sets of jaws

## Part number

6YTTL03

## Jaws types

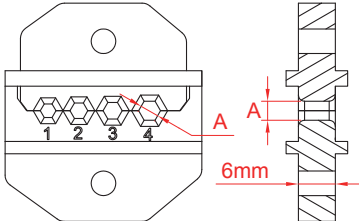
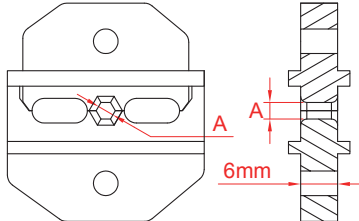
	
<p>Universal model, with 4 cavities A1=2.2mm; A2=2.5mm; A3=2.7mm; A4=3.1mm.</p>	<p>Model with one cavity, for crimping terminals with short distance from each other (A=2.2mm). Usable for crimping of models 6YTDK2</p>



**Exclusive** stripping pliers for heat tracing cables with **dedicated** cutting blades according to all cable dimensions.



Use	Wire gauge	Cables styles		Type
Workshop or field	0.5mm <sup>2</sup> ~2.5mm <sup>2</sup> (AWG22~AWG14)	Round of oblongs		

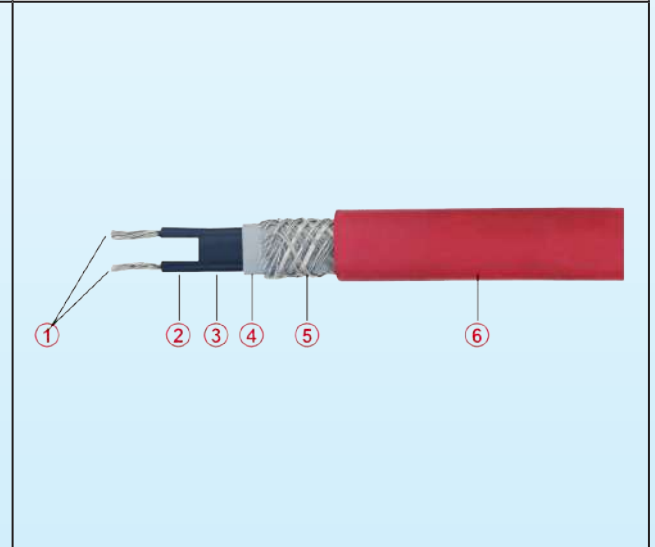
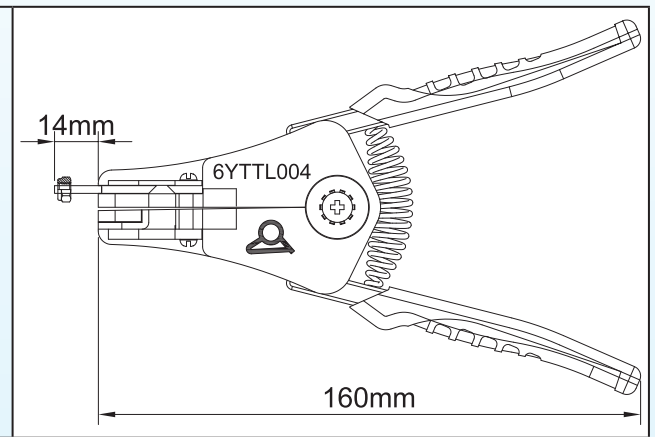

Case with all sets of stripping jaws

**Common composition of a self-regulating cable**  
**1:** Metal conductors, from 1 to 2mm<sup>2</sup>  
**2:** Conductors still covered with semiconductor compound (the one whose stripping is the most difficult)  
**3:** Heating semiconductor area  
**4:** Electrical insulation jacket of the heating zone  
**5:** Metal braid or ribbon + earth conductor  
**6:** Outer protection jacket

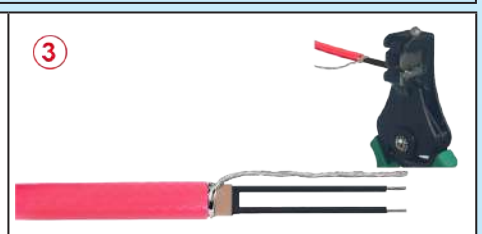
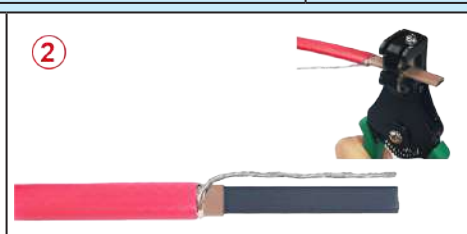
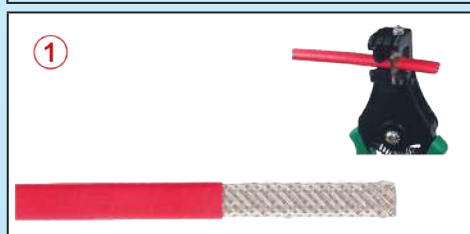

**Possible operations with this tool:**  
**1:** Remove the outer jacket  
**2:** Remove the electrical insulating jacket  
**3:** Strip the bus wires

Because of permanent improvement of our products, drawings, descriptions, features used on these data sheets are for guidance only and can be modified without prior advice

### Applications

Special stripping pliers **particularly suitable for oblong heating cables with two conductors.** The stripping and stripping of these oblong conductors is a long and difficult operation, causing a lot of waste. We **have specially developed** these tools in order to reduce waste and considerably reduce installation times.

### Main features

There are a whole series of models in various sizes of heating cables. These cables can have up to 4 different layers made of several materials. For more information, see the technical introduction to this catalog which describes them. These layers can be made of different materials, more or less flexible, the most rigid and difficult to remove being that of carbon filled polyethylene core used in the low and medium temperature self-regulating cables.

**Jaws:** They exist in two configurations.

- *Bus wire stripping jaws.* They are differentiated by the spacing of the conductors and their diameter. In the case of self-regulating cables with carbon filled polyethylene, we recommend stripping the wires one by one. **Softening the polyethylene core with a lighter or heat gun may be necessary in some cases.**

- *Protective jackets removal jaws:* They are defined by the external dimension of the cable **after** jacket removal. These jaws have a cutting depth adjustment to avoid to cut the braid

**Production of special clamps:** Possible on request, send us cable samples

**Each plier is shipped in a plastic professional case with a set of 6 jaws described below. Selected jaws numbers must be provided with order**

### Part number

6YTTL04

### Jaws spare parts numbers

#### Jaws for bus wires stripping

Size	Bus wires distance	Wires diameter	Gauge	Marking	Part numbers
<p><b>A1</b></p>	2.5 3.8 5 7	1 to 1.5mm	0.5 to 1.5mm <sup>2</sup>	A1	6YTTL04A1
<p><b>A2</b></p>		1.5 to 1.9mm	2 to 2.5mm <sup>2</sup>	A2	6YTTL04A2
<p><b>A3</b></p>		1.9 to 2.3mm	2.5 to 4mm <sup>2</sup>	A3	6YTTL04A3

Because of permanent improvement of our products, drawings, descriptions, features used on these data sheets are for guidance only and can be modified without prior advice



**Exclusive stripping pliers for heat tracing cables with dedicated cutting blades according to all cable dimensions.**



**Jaws for oblong cables outer and inner jackets removal**



Size	Cable outside dimension after jacket removal	Marking	Part numbers	Size	Cable outside dimension after jacket removal	Marking	Part numbers
	5 × 10mm	B1	6YTTL04B1		1.8 × 9.8mm	B7	6YTTL04B7
	2.1 × 7mm	B2	6YTTL04B2		7.2 × 12.7mm	B8	6YTTL04B8
	5.5 × 10.5mm	B3	6YTTL04B3		3.7 × 9.3mm	B9	6YTTL04B9
	2.2 × 7.5mm	B4	6YTTL04B4		7.7 × 12.7mm	B10	6YTTL04B10
	6.8 × 10.5mm	B5	6YTTL04B5		4.2 × 9.3mm	B11	6YTTL04B11
	5 × 12mm	B6	6YTTL04B6				

Because of permanent improvement of our products, drawings, descriptions, features used on these data sheets are for guidance only and can be modified without prior advice

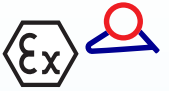
# Guillotine notching plier for cutting the heating zone between the conductors of oblong self-regulating cables

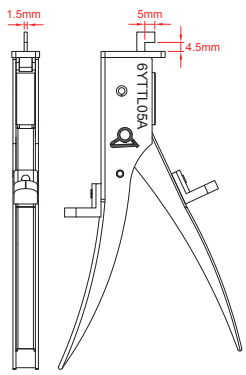
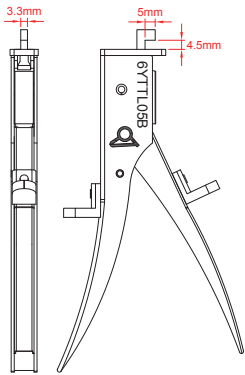
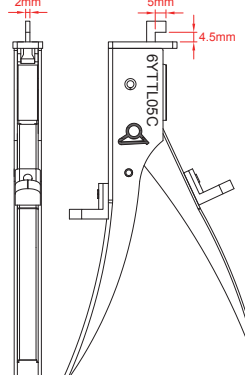
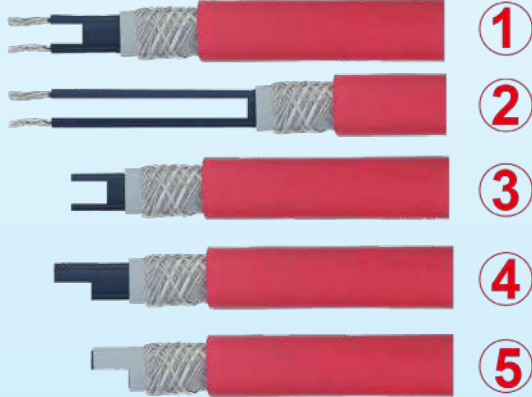
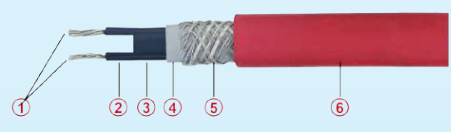

Because of permanent improvement of our products, drawings, descriptions, features used on these data sheets are for guidance only and can be modified without prior advice

Use	Notch width	Cables styles		Type
Workshop or field	1.5mm 2mm 3.3mm	Oblongs, self-regulating		
				
		6YTTL05A	6YTTL05B	6YTTL05C
				
<p><b>Types of cuts that can be made</b></p> <ol style="list-style-type: none"> <li>1: Short section of the heating zone for use in conventional connection boxes.</li> <li>2: Long section of the heating zone for connection for use in the tube mounting feet.</li> <li>3: Short section of the heating zone for connection in boxes with insulation piercing system to respect the 5mm distance between bus wires</li> <li>4: Half-width section of the heating zone for connection in boxes with insulation piercing system to respect the 5mm distance between bus wires.</li> <li>5: Half-width section with insulation for termination on free end of the cable without silicone gel filling or without RTV filling.</li> </ol>		<p><b>Common composition of a self-regulating cable</b></p> <ol style="list-style-type: none"> <li>1: Metal conductors, from 1 to 2mm<sup>2</sup>.</li> <li>2: Conductors still covered with semiconductor compound (the one whose stripping is the most difficult).</li> <li>3: Heating semiconductor area.</li> <li>4: Electrical insulation jacket of the heating zone.</li> <li>5: Metal braid or ribbon + earth conductor.</li> <li>6: Outer protection jacket.</li> </ol>		

## Applications

We **specifically developed this guillotine hand shear** to solve two specific problems with low and medium temperature self-regulating cables:

- The difficulty of cutting the carbon filled polyethylene heating zone between the 2 bus wires.
- The obligation to maintain a mandatory insulation distance between the bus wires of these heating cables when they are connected to a terminal block or to one cable end seal. This minimum insulation distance depends on the use of the cable: In an industrial environment in a **non-explosive atmosphere**, this distance can range from 2 to 3.6mm depending on the materials. In an industrial environment and **explosive atmosphere**, using a type EX "e" connection, this minimal distance is 5mm. (See standards EN60079-7 and EN60947).

This tool allows to **cut easily the polyethylene matrix** to respect these distances in all cases.



# Guillotine notching plier for cutting the heating zone between the conductors of oblong self-regulating cables



## Main features

According to the different models of the different manufacturers of self-regulating heating cables, the distance between the bus wires is highly variable, ranging from 1.5 to 4.2mm.

### Jaws:

*Notch length:* 5mm for each manual cutting operation.

*Notch width:* They exist in three configurations, allowing to cover the different spacings between existing between bus wires.

- Cables with distance between bus wires from 1.5 to 2mm.
- Cables with distance between bus wires from 2 to 3.3mm.
- Cables with distance between bus wires from 3.3 to 4.2mm.

This last model also allows cutting cables and conductors according to type 4 and 5 cuts.

**Production of special pliers:** Possible on request, send us cable samples.

Each guillotine notching plier is delivered in a professional box with a set of cable dimension guides

## Part numbers

6YTTL05A	Guillotine notching plier for cables with distance between bus wires from 1.5 to 2mm.
6YTTL05B	Guillotine notching plier for cables with distance between bus wires from 2 to 3.3mm.
6YTTL05C	Guillotine notching plier for cables with distance between bus wires from 2 to 3.3mm and types 4 and 5 cuts.
6YTTL05D	Set of 3 guillotine notching pliers with the 3 sets of jaws.



Because of permanent improvement of our products, drawings, descriptions, features used on these data sheets are for guidance only and can be modified without prior advice

---

Contact us

[www.ultimheat.com](http://www.ultimheat.com)



# ULTIMHEAT

---

## HEAT & CONTROLS



Catalogues collection on  
[www.ultimheat.com](http://www.ultimheat.com)

**Electromechanical components & OEM heating sub-assemblies manufacturer**

- Mechanical thermostats
- Mechanical safeties single & three poles
- ATEX thermostats & safeties
- Flow through liquid heaters
- Immersion heaters
- Heating elements for air and liquid
- Connection blocks
- Housings for corrosive environments
- Flow switches
- Level switches
- Pressure switches and air switches
- Fusible links and fire detection mechanisms
- Tracing equipment
- **Taylor made solutions**



**4** **5**

# EXPLOSION PROOF & CONNECTION BOXES